

PSRIP  
GRADE 1  
TERM 4 2021

FIRST ADDITIONAL  
LANGUAGE  
ENGLISH

RESOURCE PACK

**WEEKS**

**1 & 2**

# Solving problems

**ss**

**mass**

**sass**

**lass**

miss

kiss

hiss

problem

solve

creative

idea

paint

lose

find

stare

art

artist

children

fingers

leaf



leaves

buy

think

try

can't

find

but

it

z

zög

zob

zög

jam

jug

jet

wise

argue

shout

mine

tree

mango

mangoes

shade

cut

wood

root

branch

half

fair

unfair

save

own



owner

belong

tricky

tree

mine

no

that

different

bottle cap

paintbrush

I could

not find . . .

So

I . . .

I needed

help when . . .

...helped me  
solve the  
problem.



**WEEKS**

**3 & 4**

**We grow  
and change**

qu

quit

quill

quack

quick

quip

change

taller

smarter

kinde

boys

men

girls

women

ignore

cry

feelings

free

sofa

happy

unhappy

grow

every

day



very

v

vet

van

vat

season

winter

summer

spring

autumn

jacket

cold

fluffy

freezing

fit

tight

short

grow

confused

fight

stolen

thief

drawer

put on

take off

year

does

not

too

small



comfortable

uncomfortable

supposed to

important

I feel happy and  
free when I...

My . . . helps me  
feel happy and  
free!

I used to

wear my . . .

But

then . . .

**WEEK**

**5 & 6**

**Our living  
history**



w

wag

wig

wet

wit

wall

will

history

past

present

future

busy

quiet  
↓

tailor

tram

mosque  
↓

leave

destroy

force

memory

forget

home

family

special

your

about

x

fox

**box**

**fix**

**six**

**wax**



fax

Ramadan

koekies

biscuit

tradition

fast

hungry

share

struggle

measure

knead

dough

ring

sparkle

sparkly

terrible

gasp

mother

her

bakes

Friday

neighbour

neighbourhood

barbershop

synagogue



bulldozer

remember

pass down

grandmother

great - grandmother

Two things I know about  
my family history:

1. I know that...

2. I know that...

A tradition in  
my family is . . .

This tradition

makes me feel...

**WEEKS**

**7 & 8**

**Science is**

**fun**



science

vaccine

disease

body

try

inject

needle

test

risk

protect

y

yes

y et

y uck

y um

y ip

rainbow

sky

colours

rain

sunlight

raindrop

magic

curious

sun

shine

storm

scientist

laptop

research

try

appear



love

loves

learn

just

solve

problems

fun

virus

small

large

amount

milk

maids

get

sick

computer

information

disappear

experiment

**dangerous**

I feel curious about:

1.

2.



I want to

• invent . . .

I want it

to...

**WORD**

**FAMILIES**

**- dss**

**- dx**

**- es**

**- iss**

-ix

-og

-ox

-uck

- um

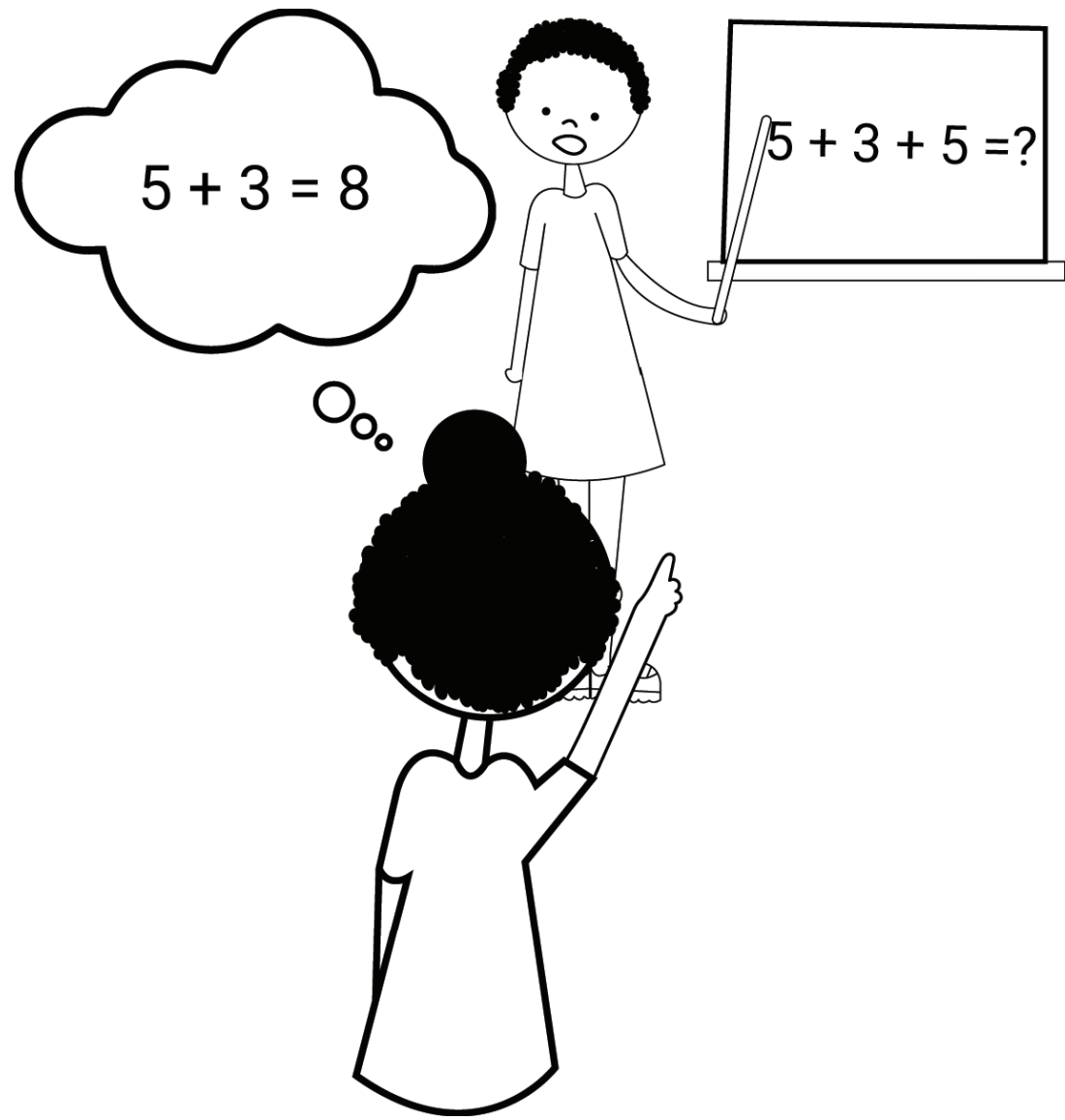

solve

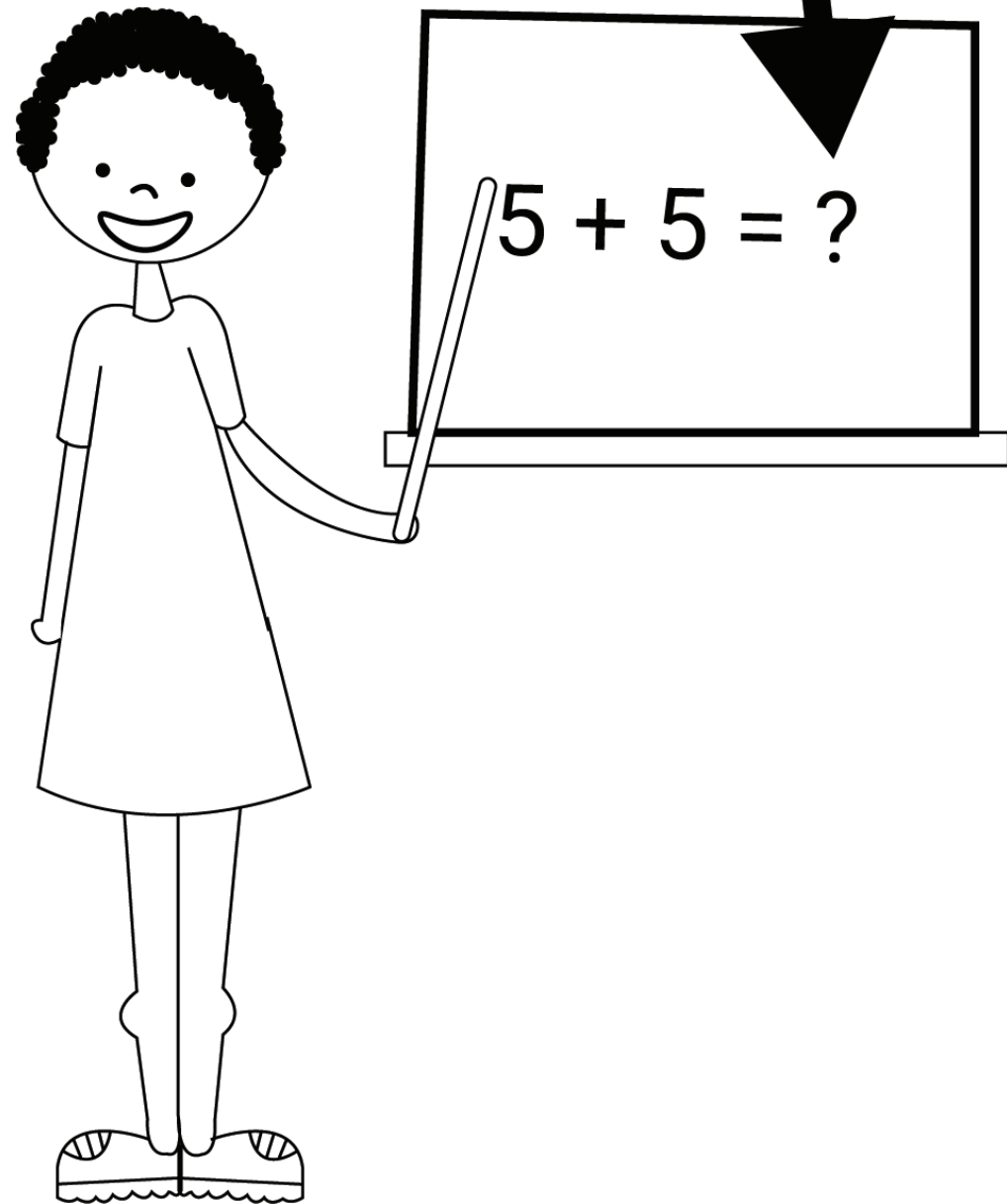

problem

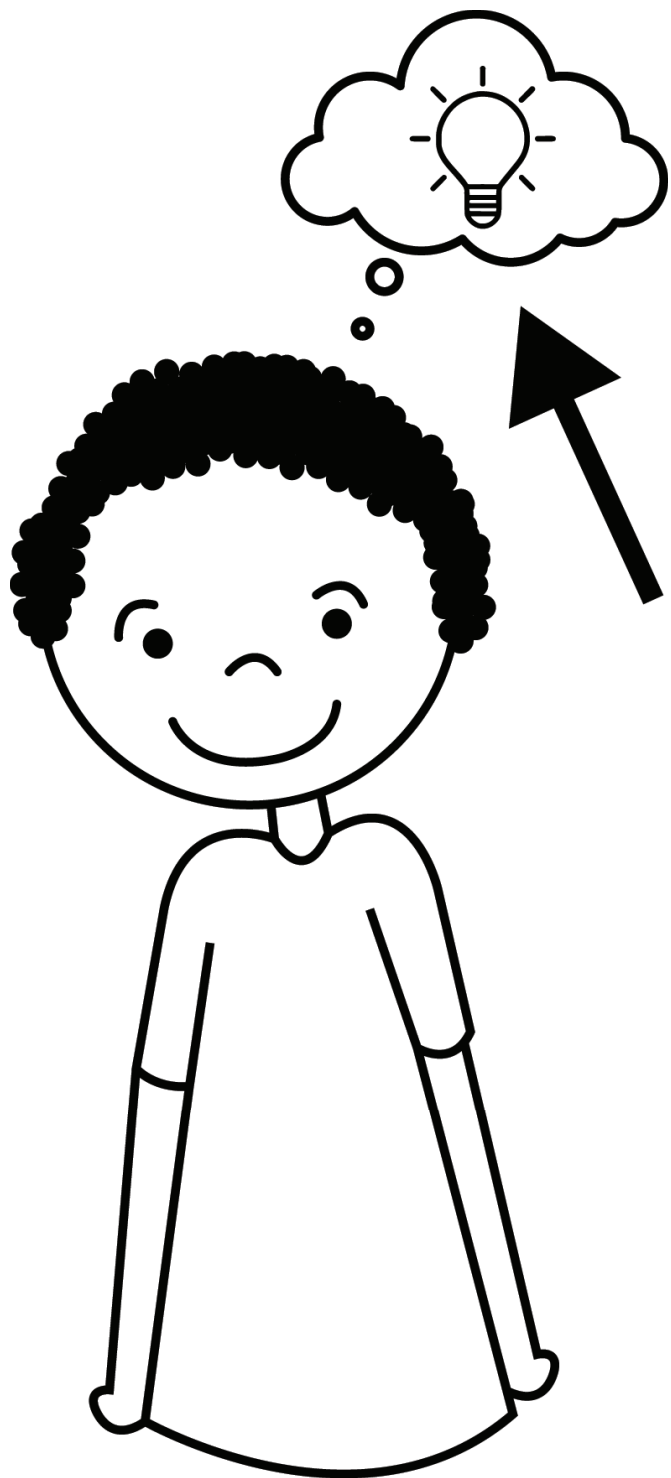

idea

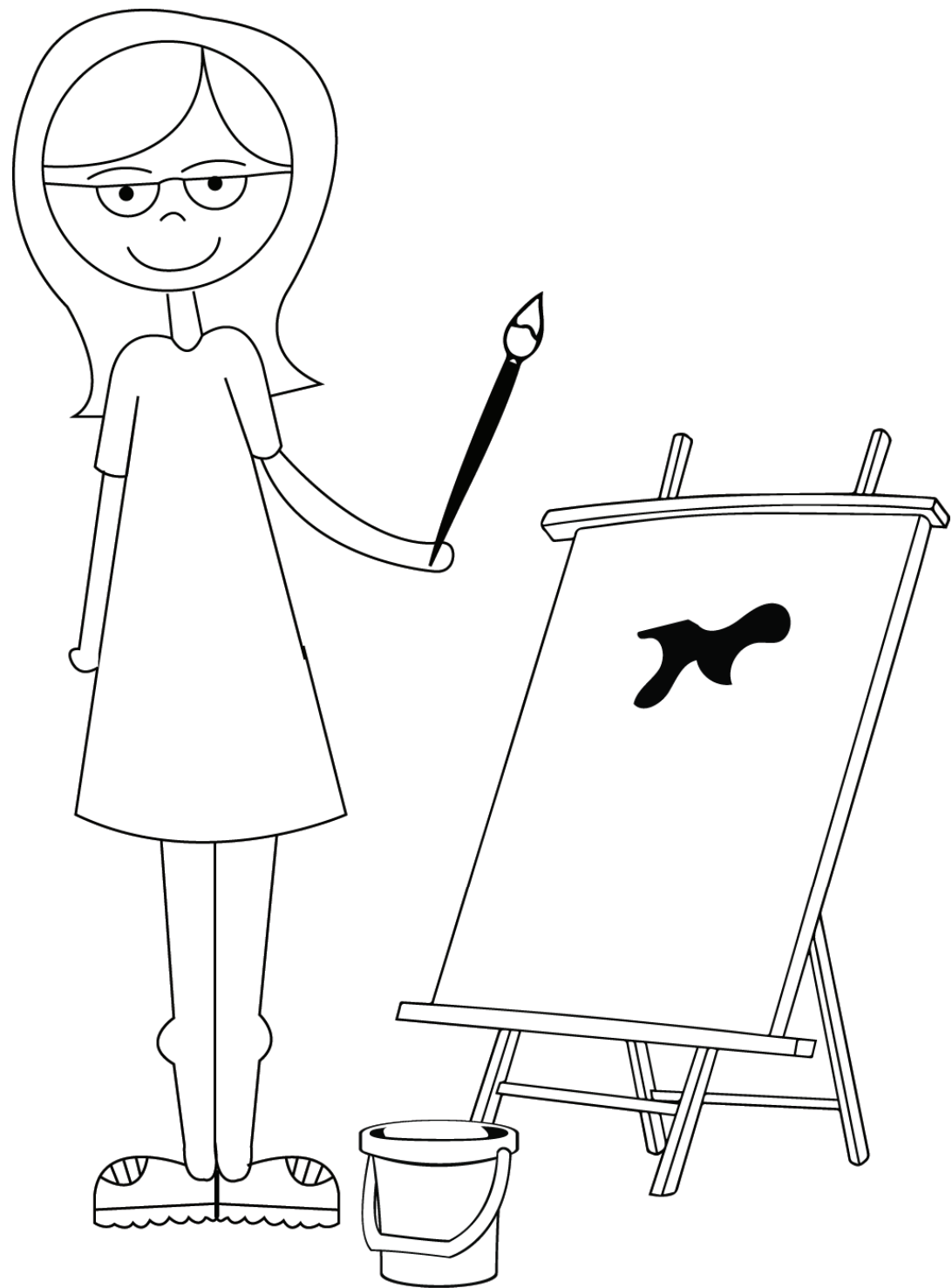

creative





paintbrush

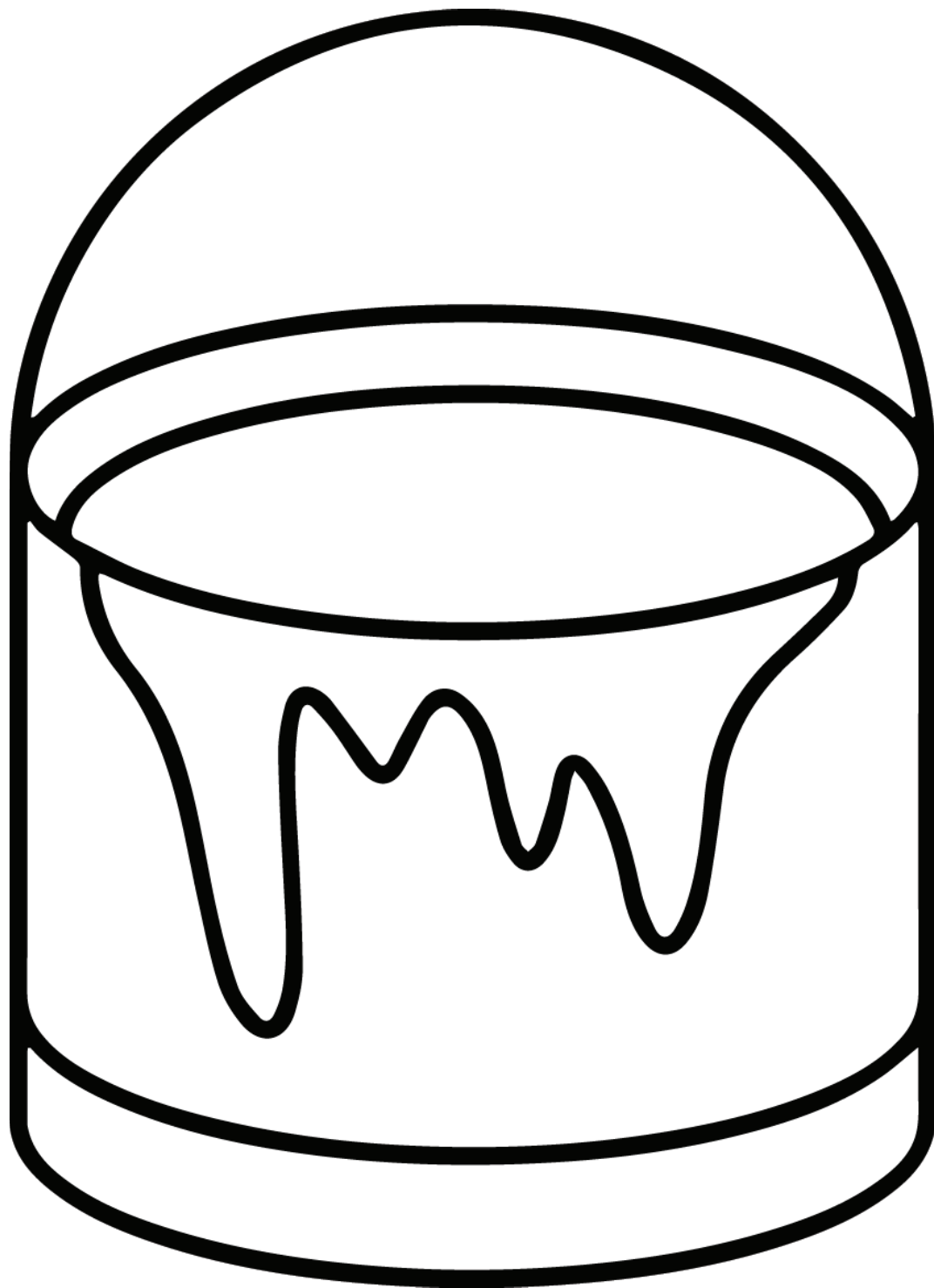

paint



find



lose



art

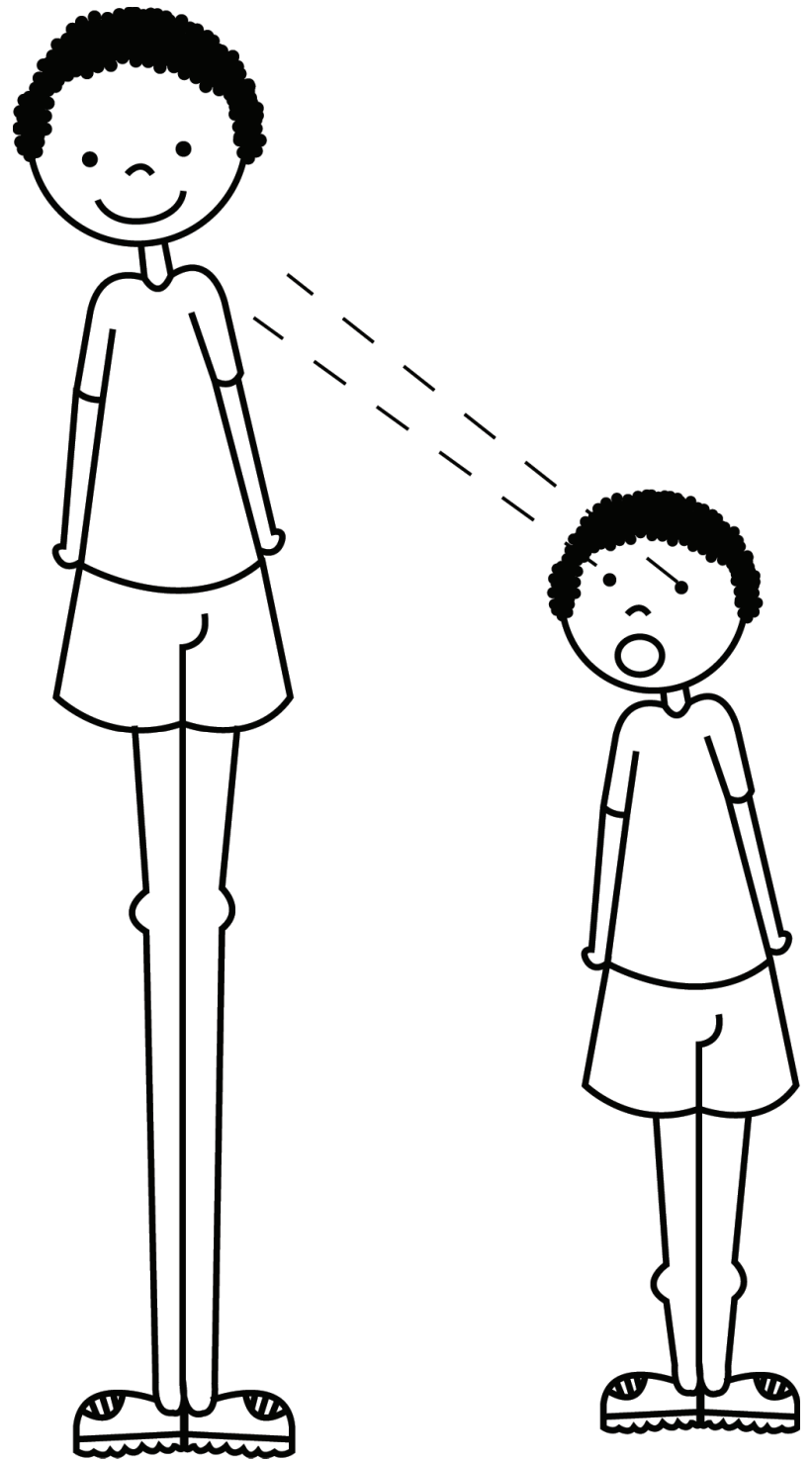

stare

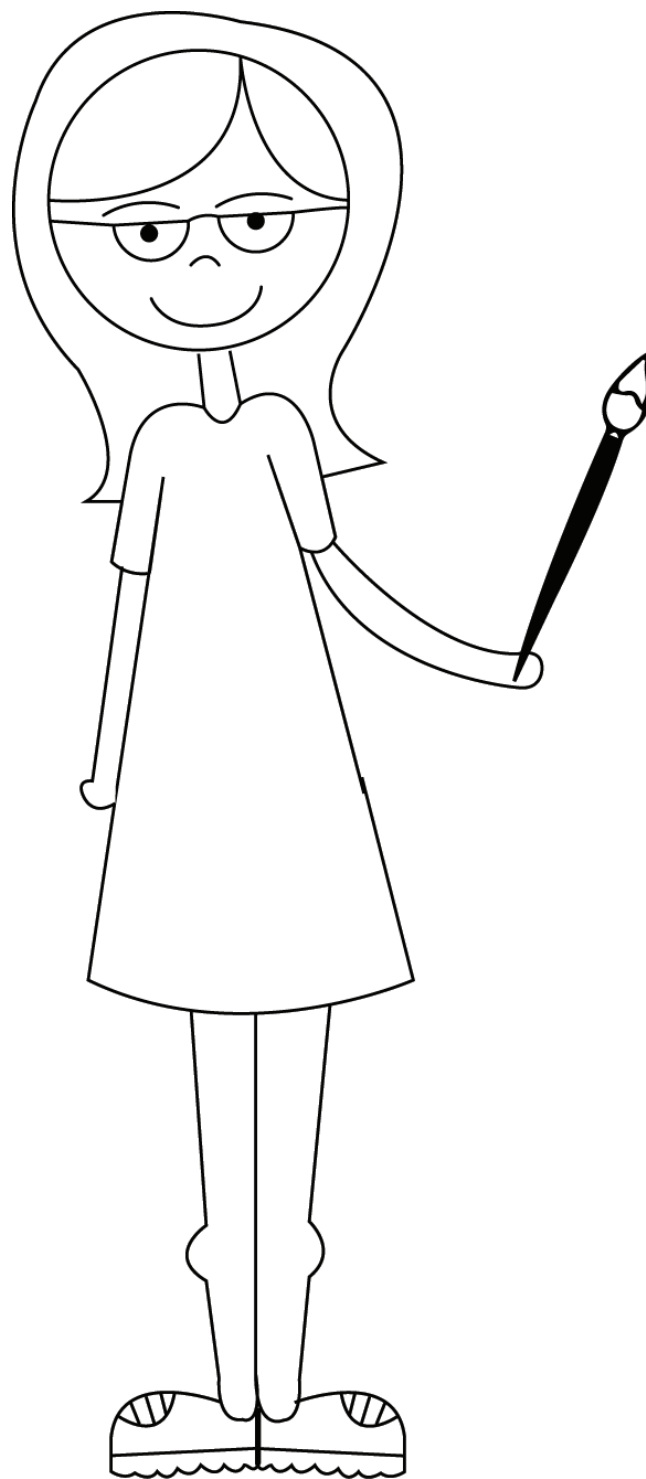
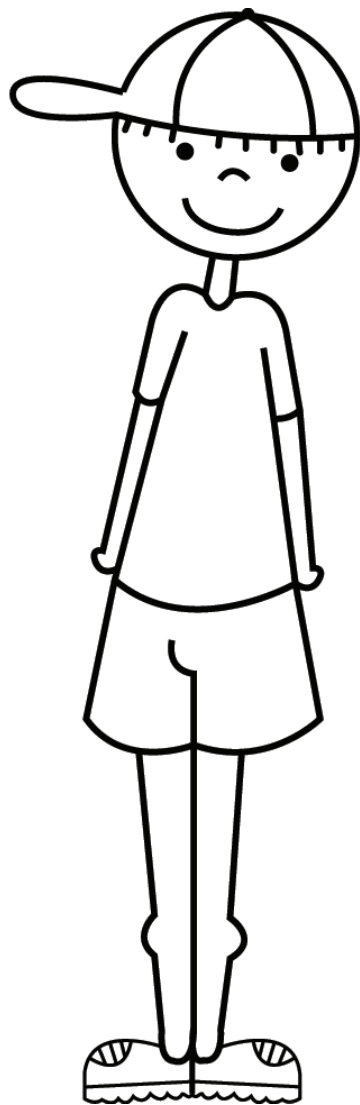
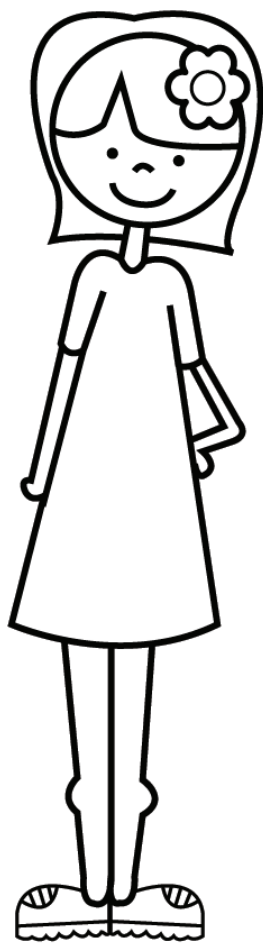
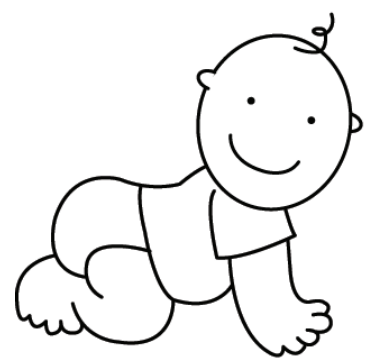

children

artist

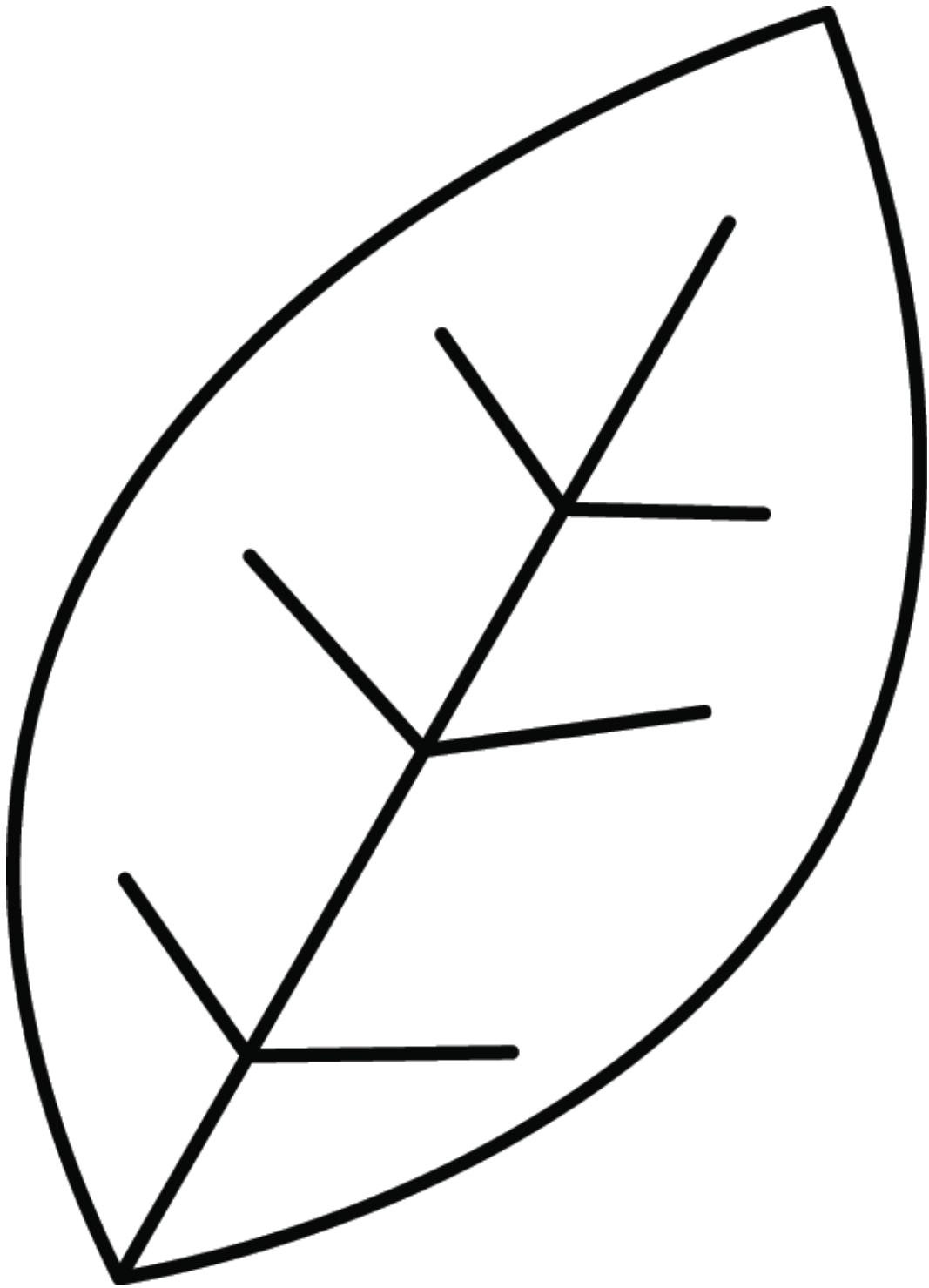

leaf

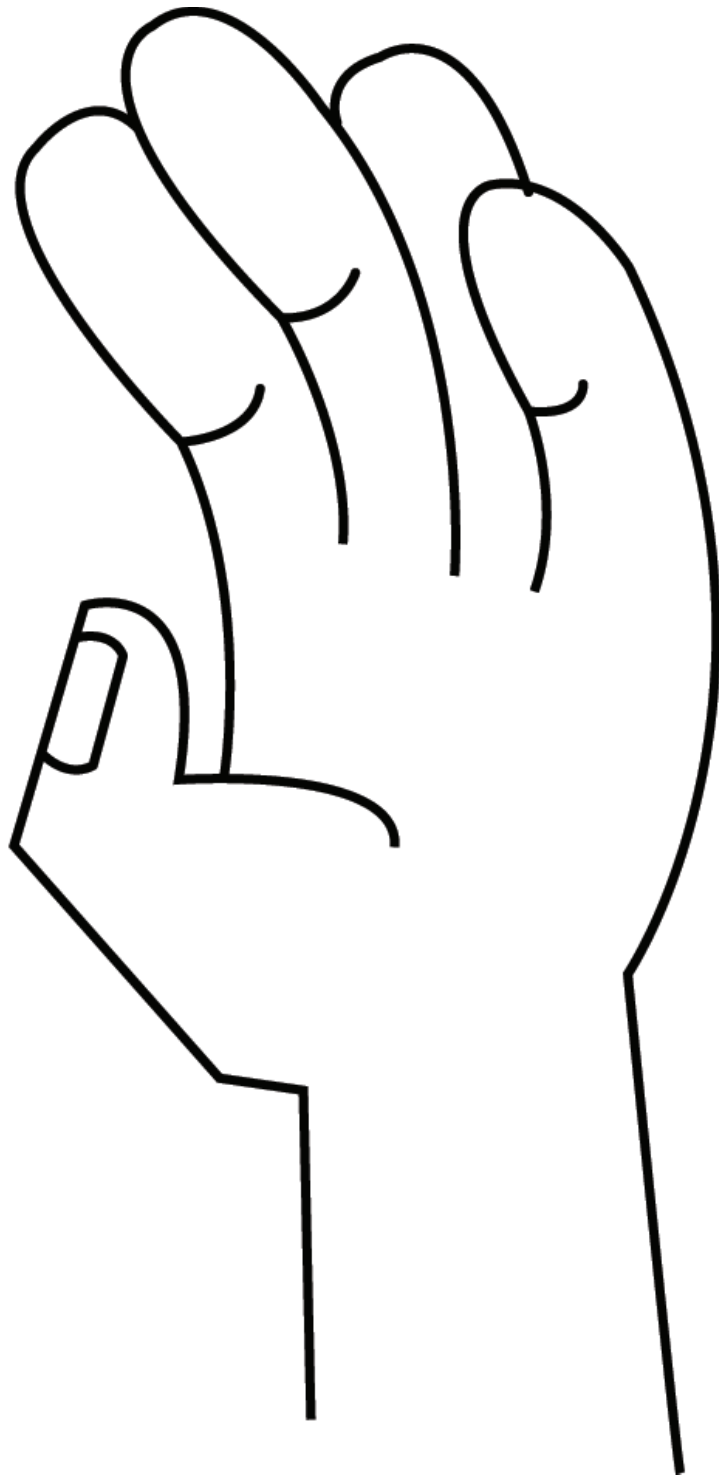

fingers

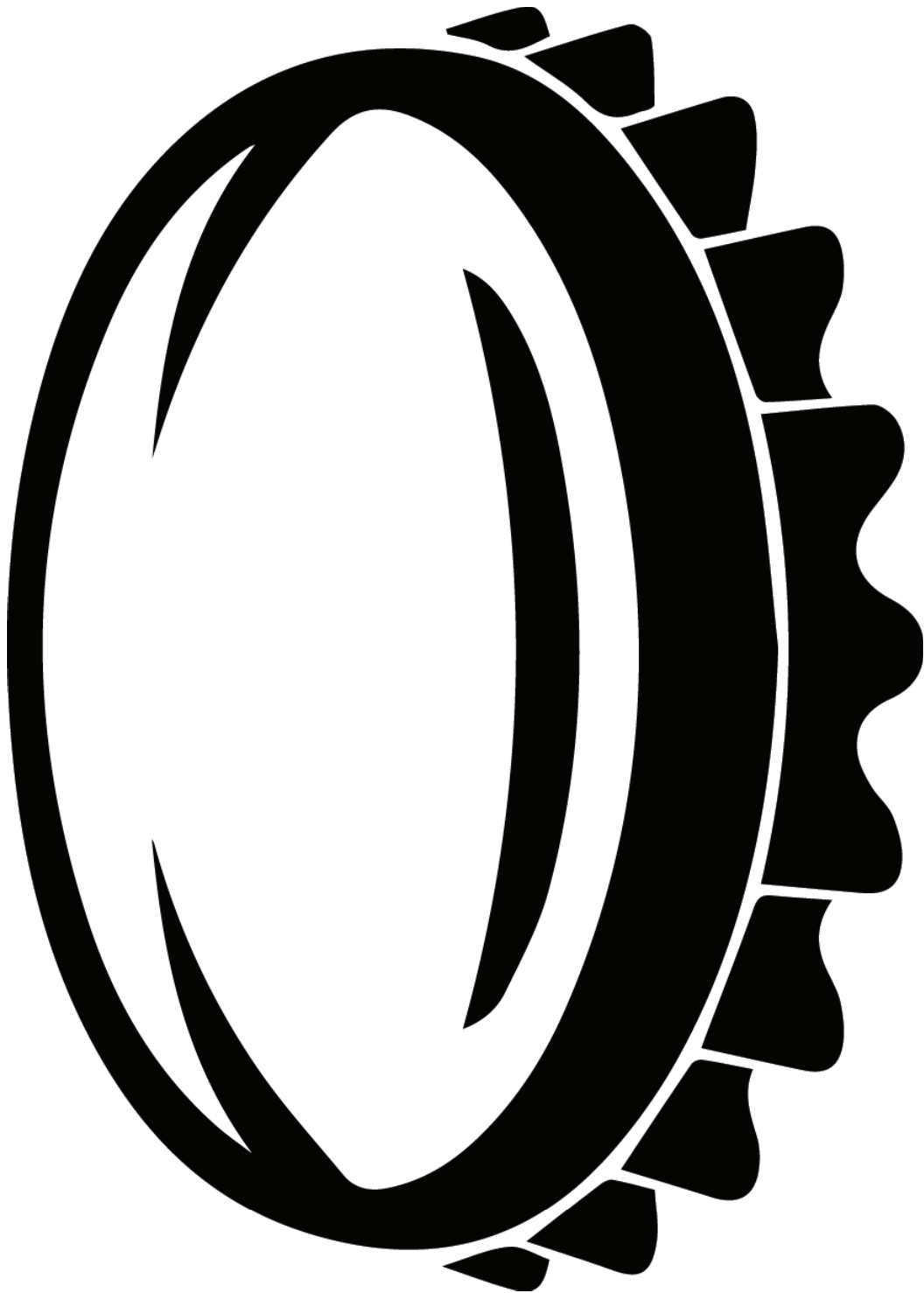

bottle cap

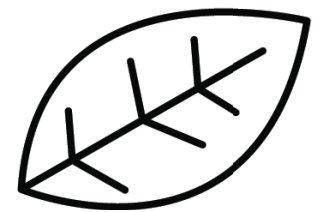
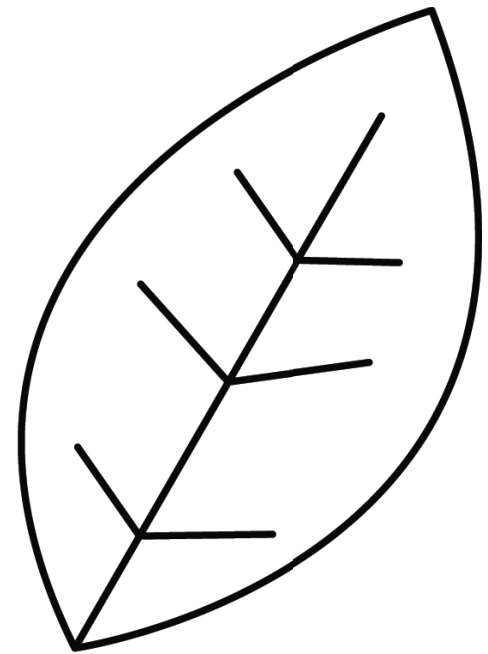
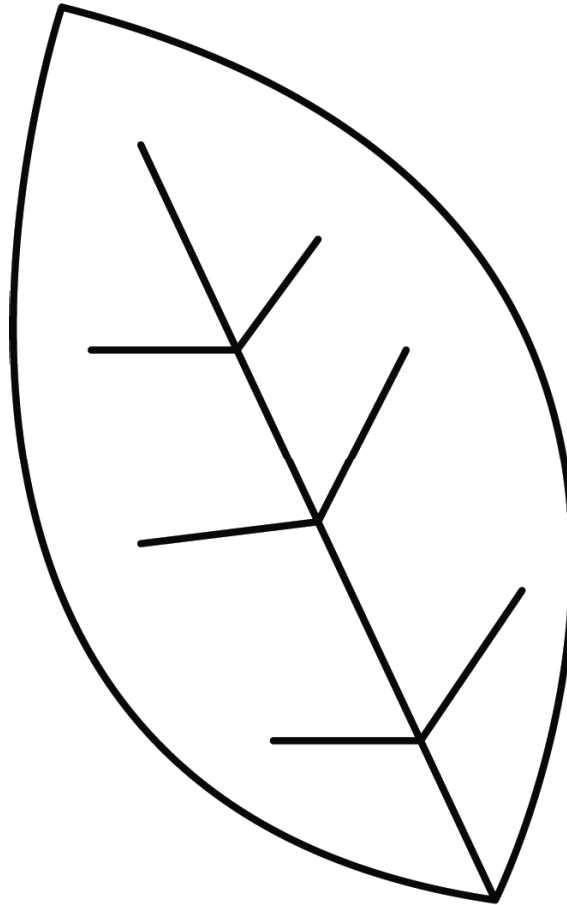

leaves

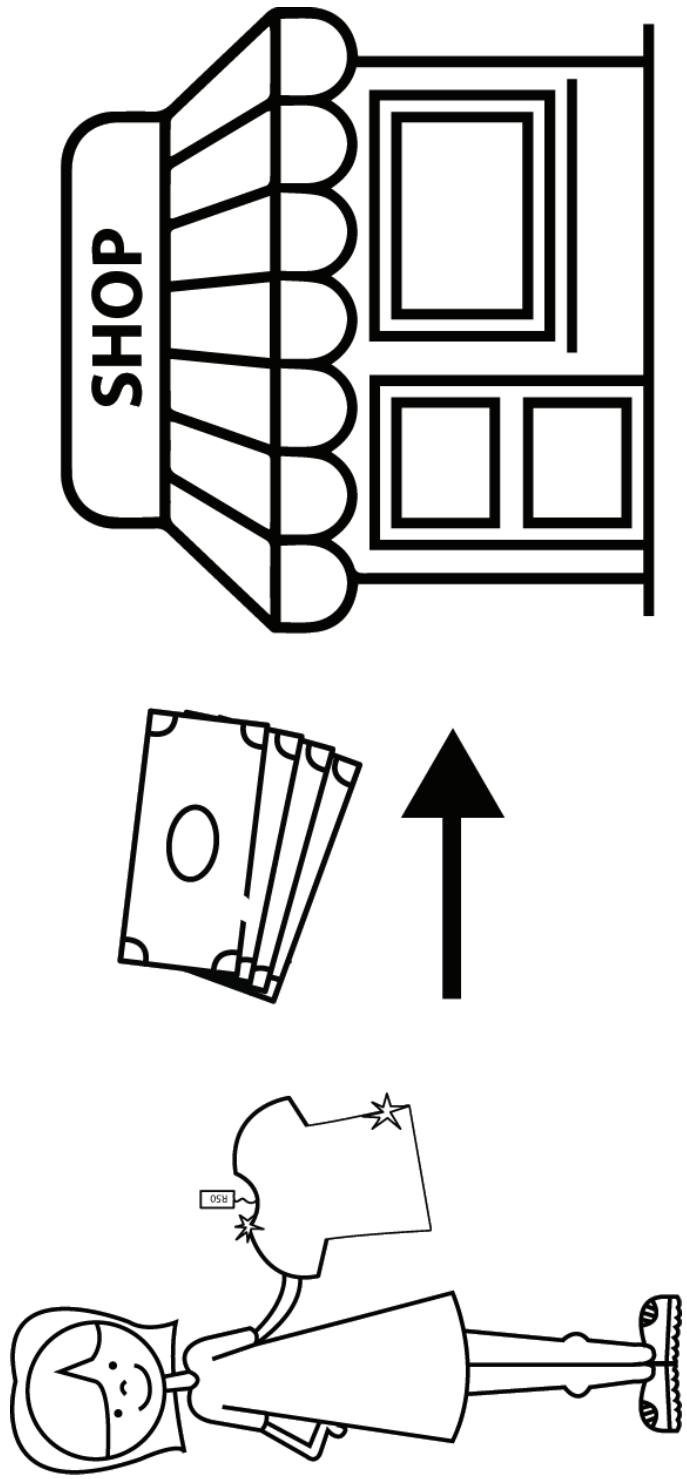

buy

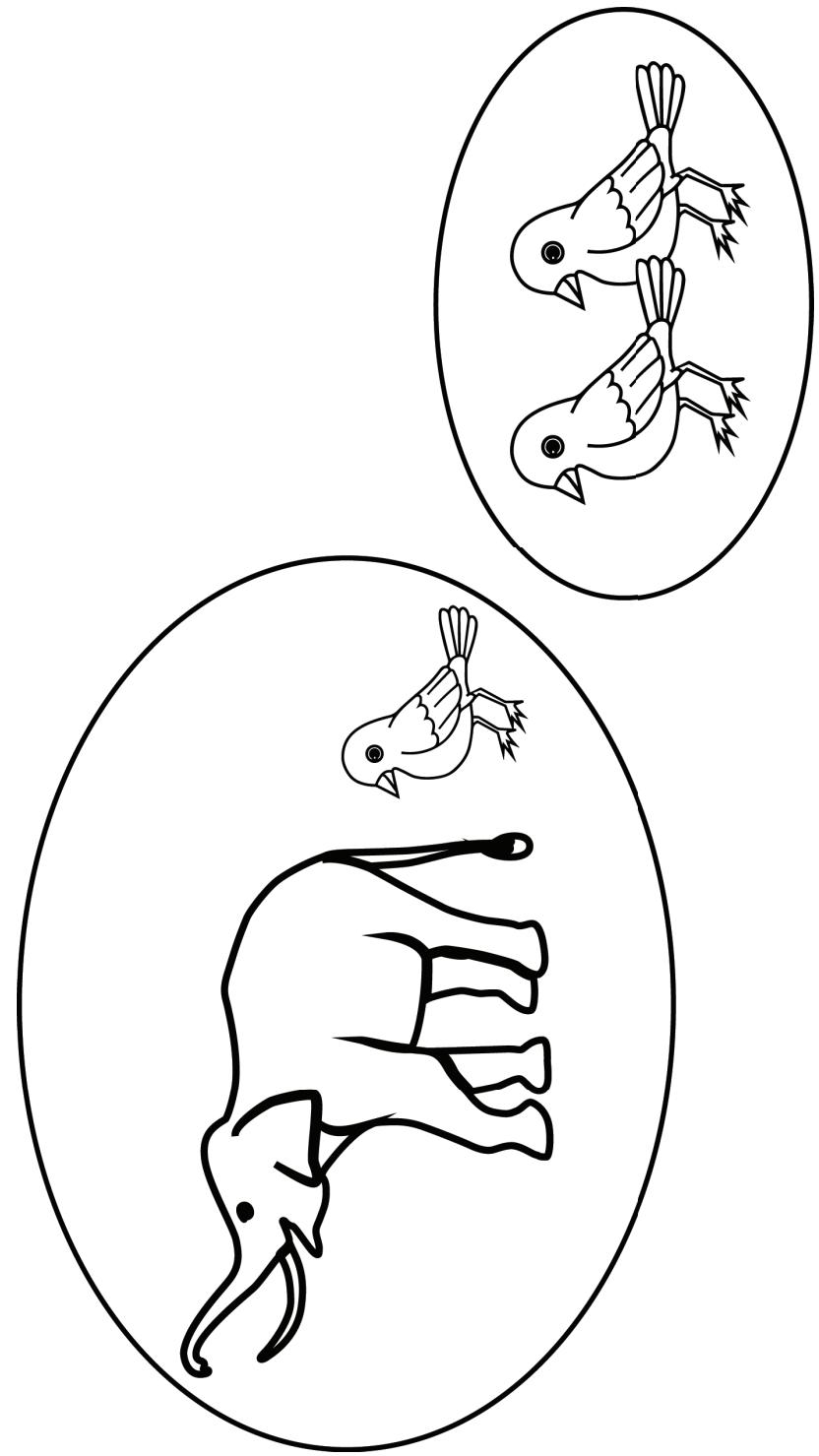

different



wise

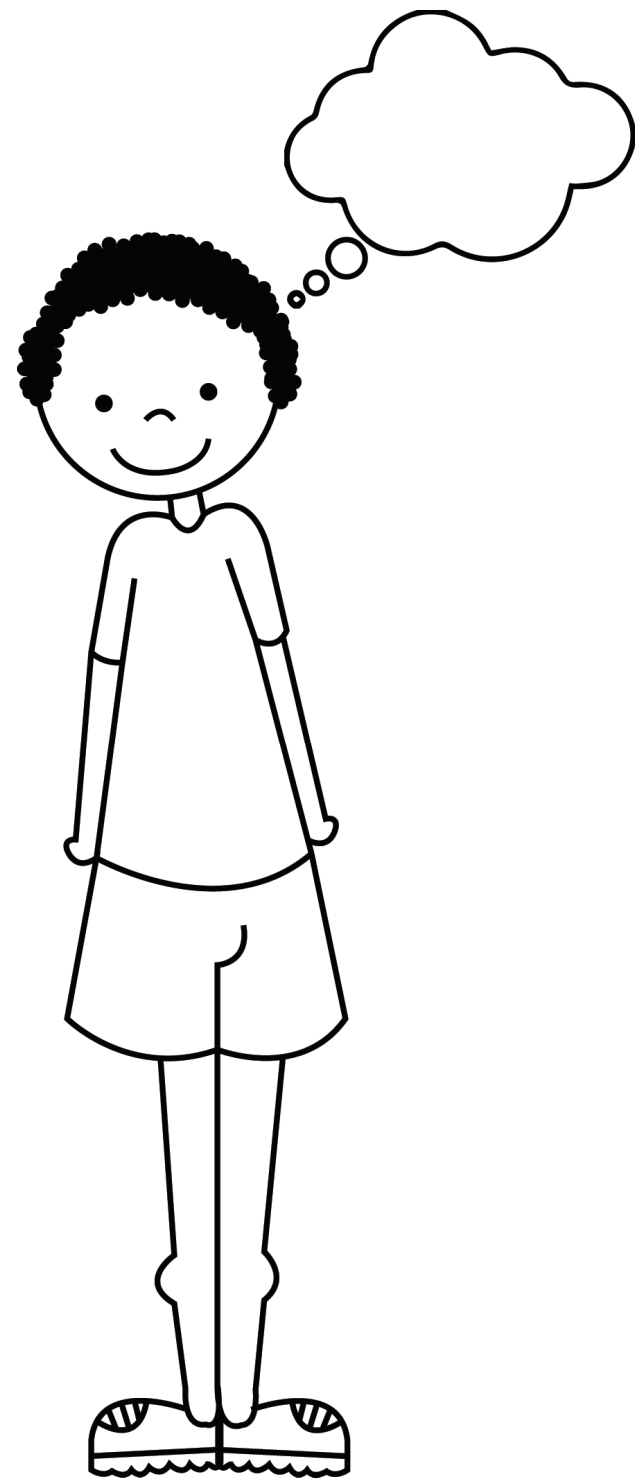

think





shout

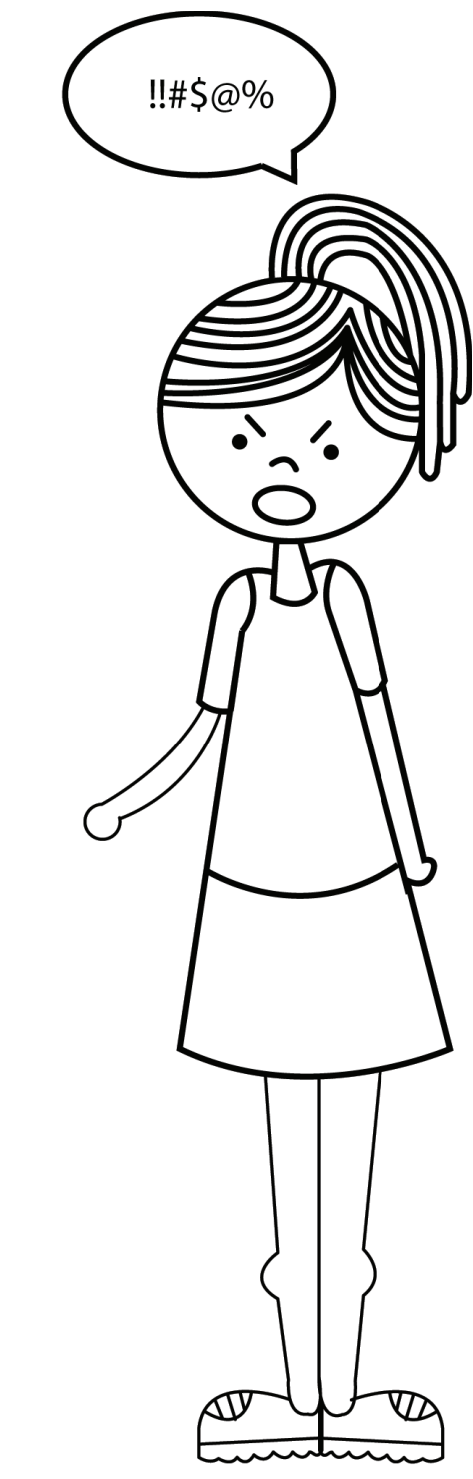
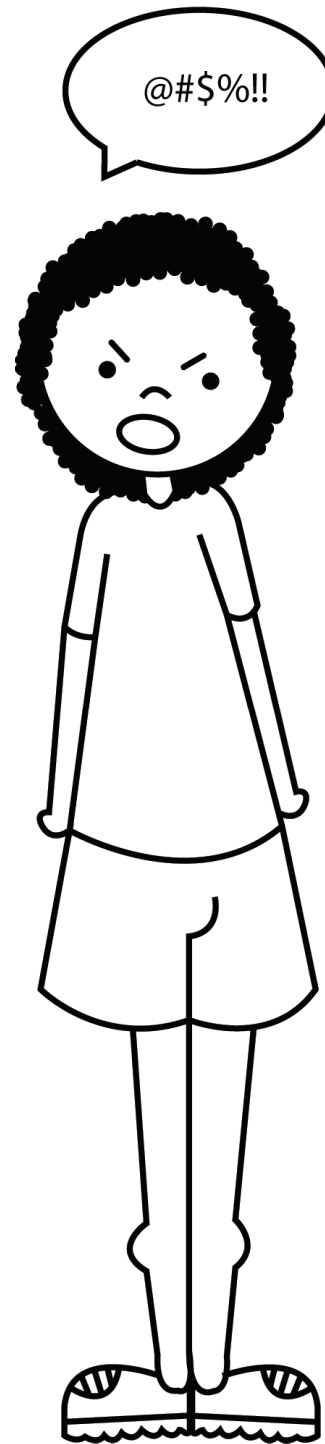

argue

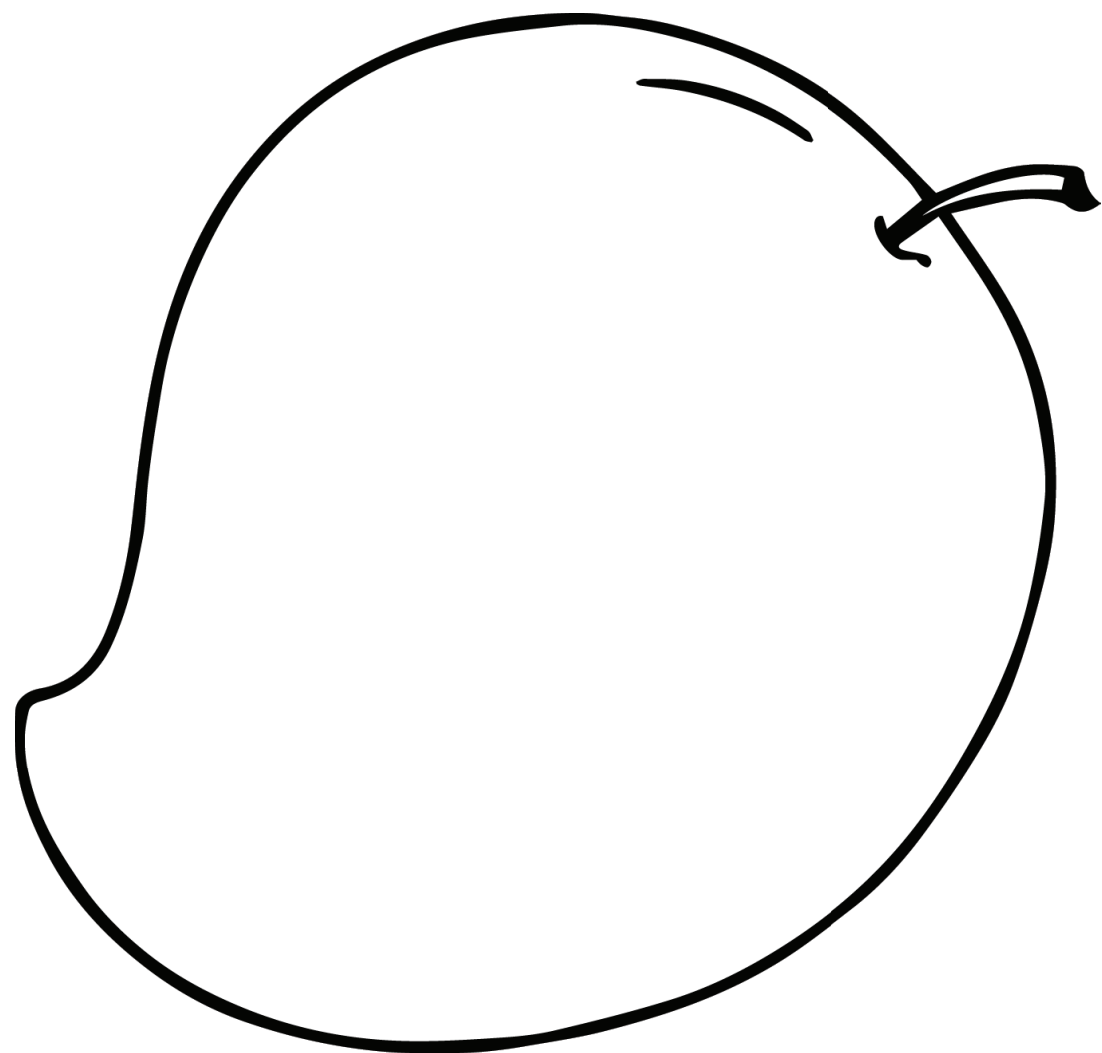

mango

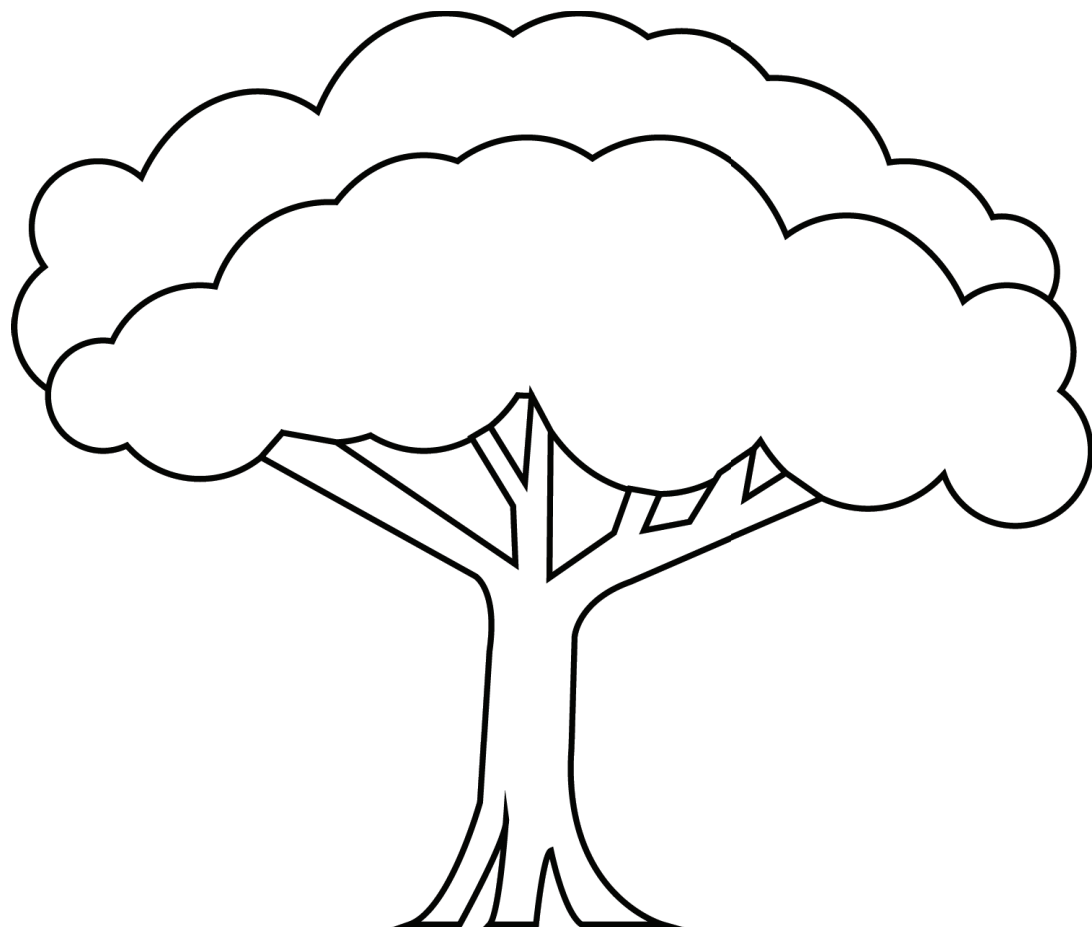

tree

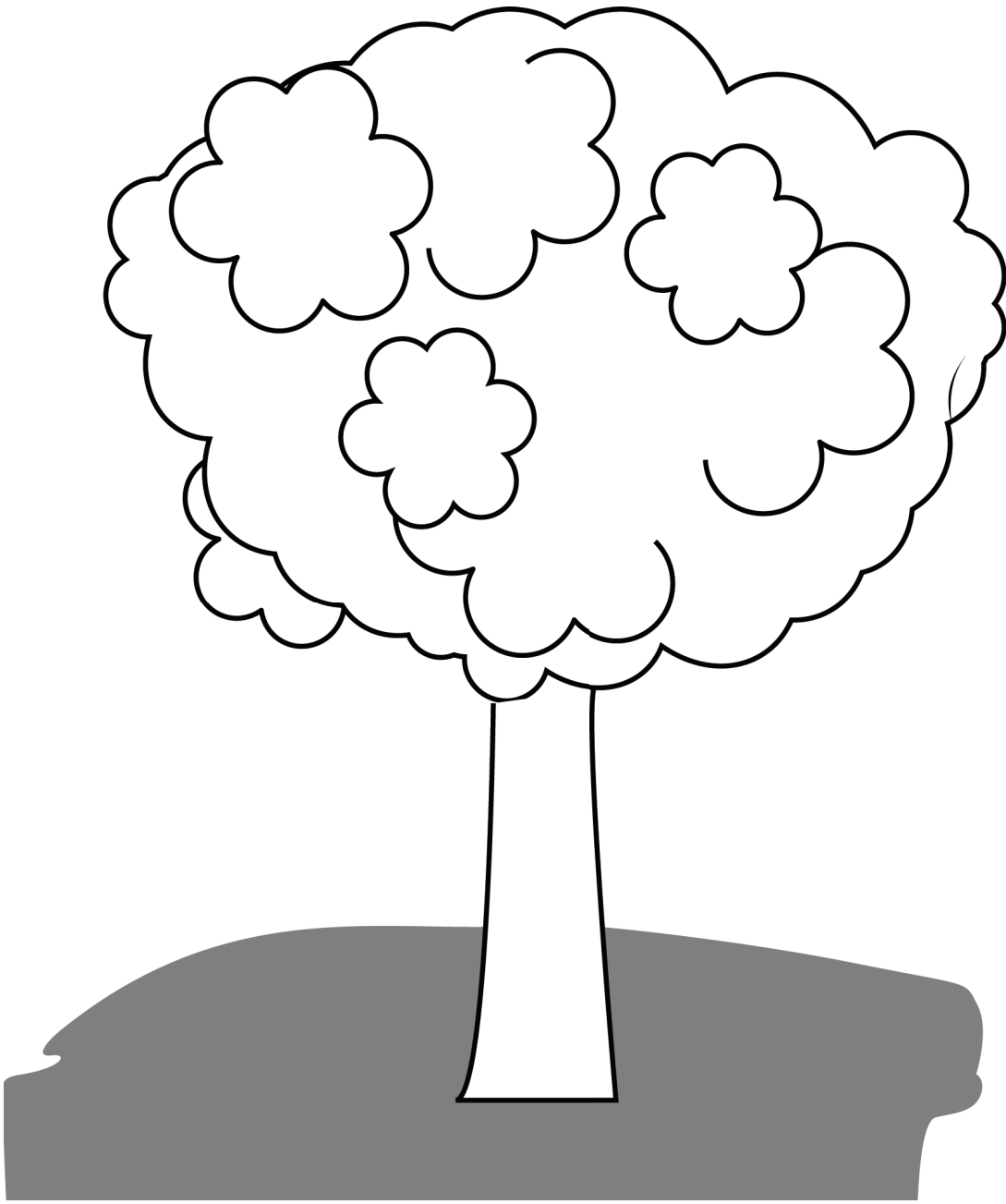

shade

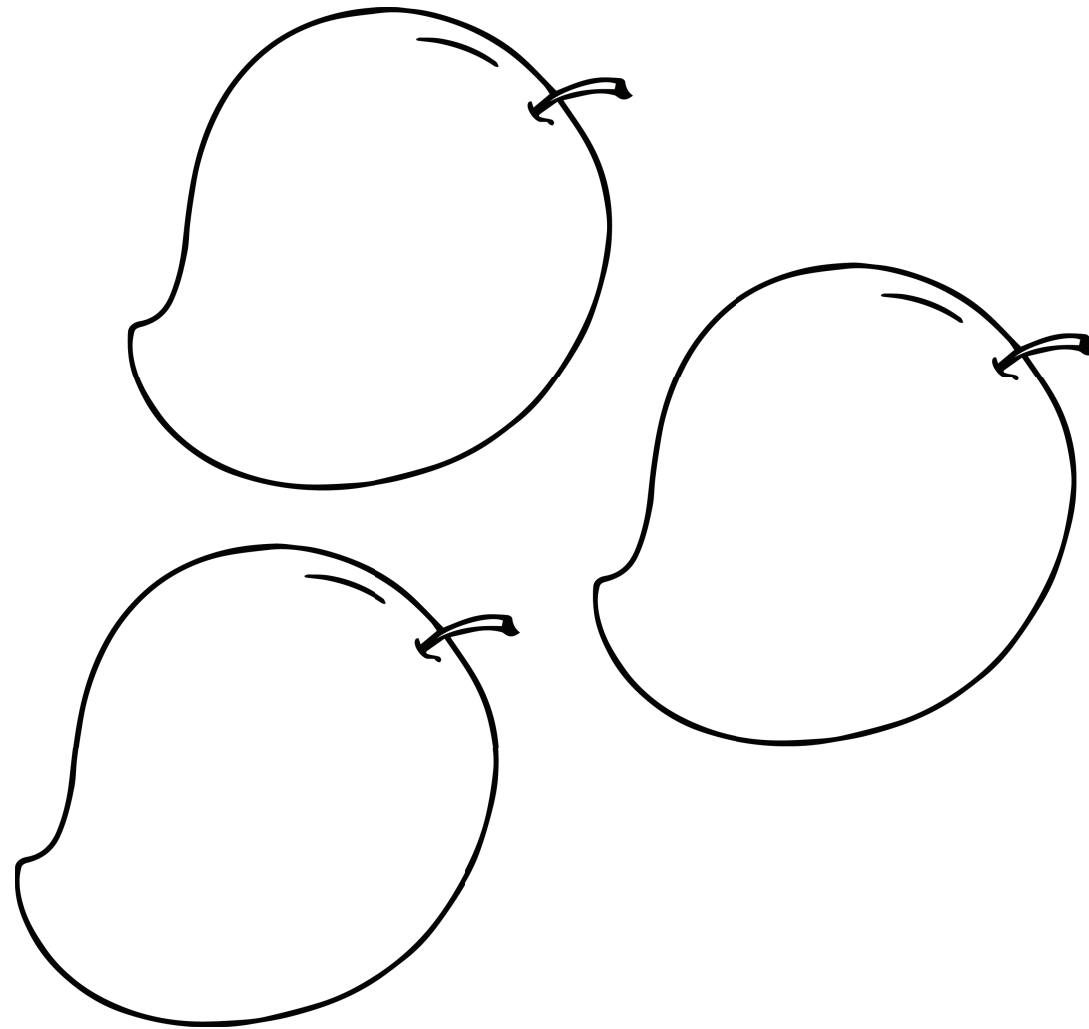

mangoes

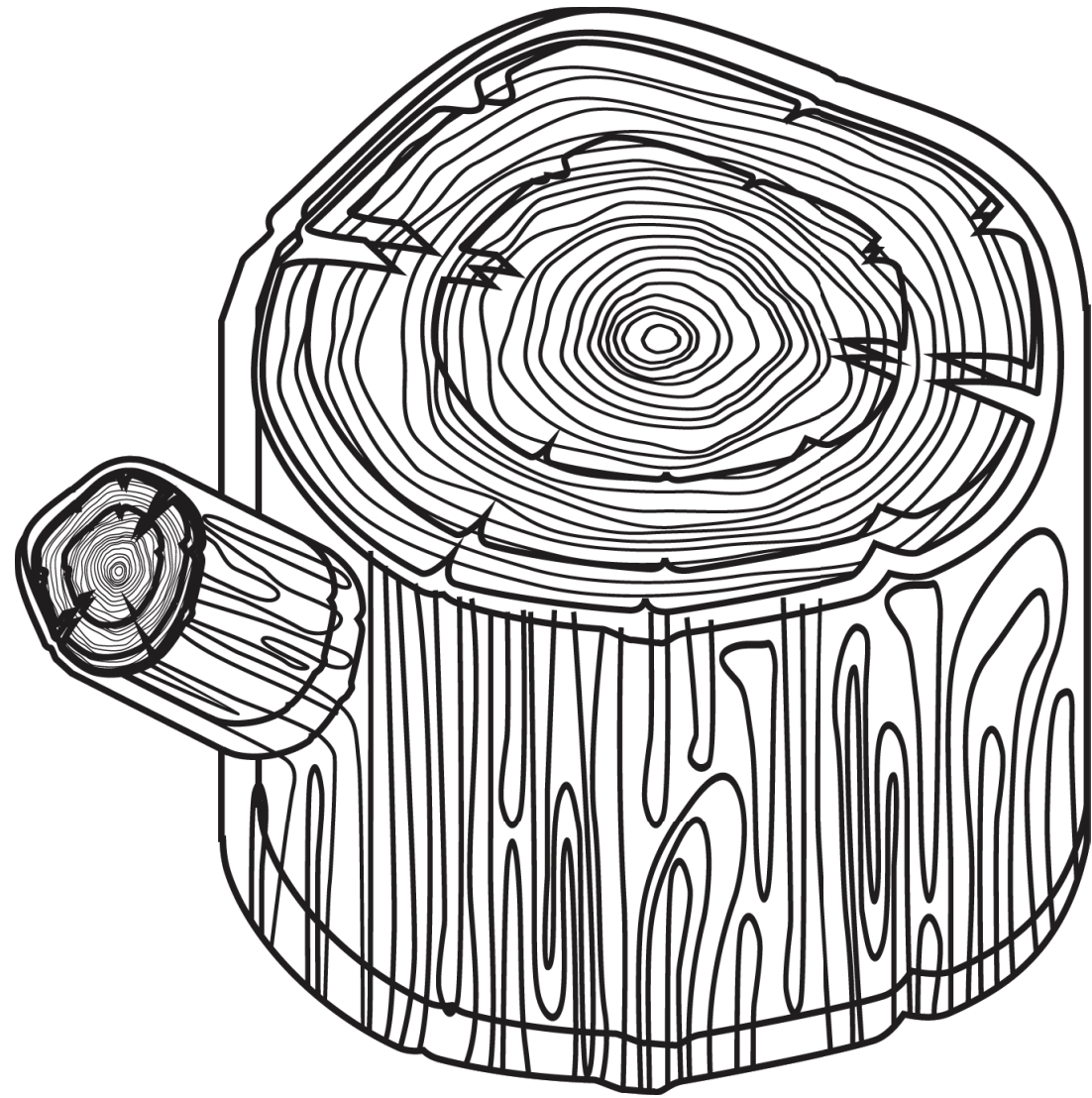

wood

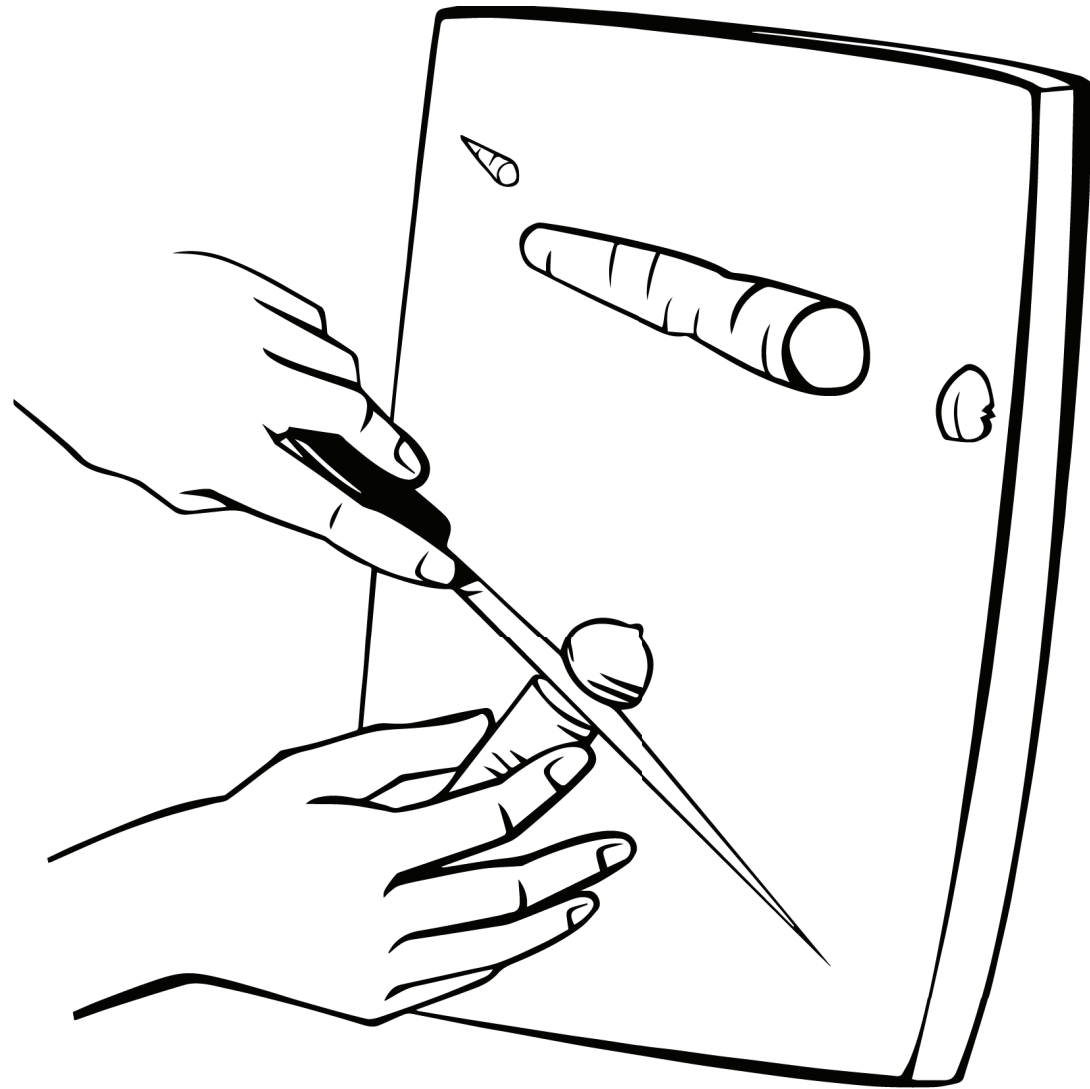

cut

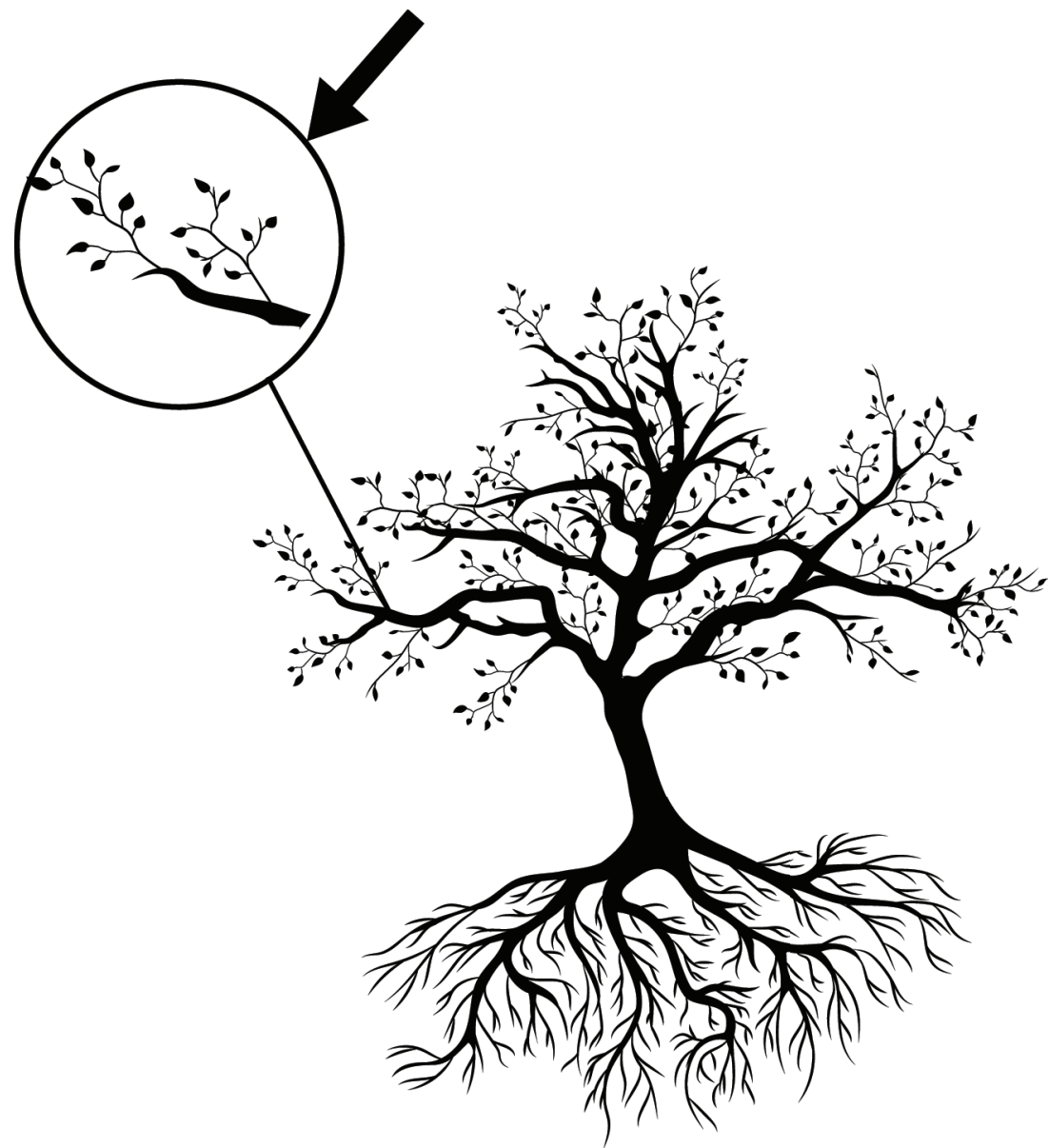

branch

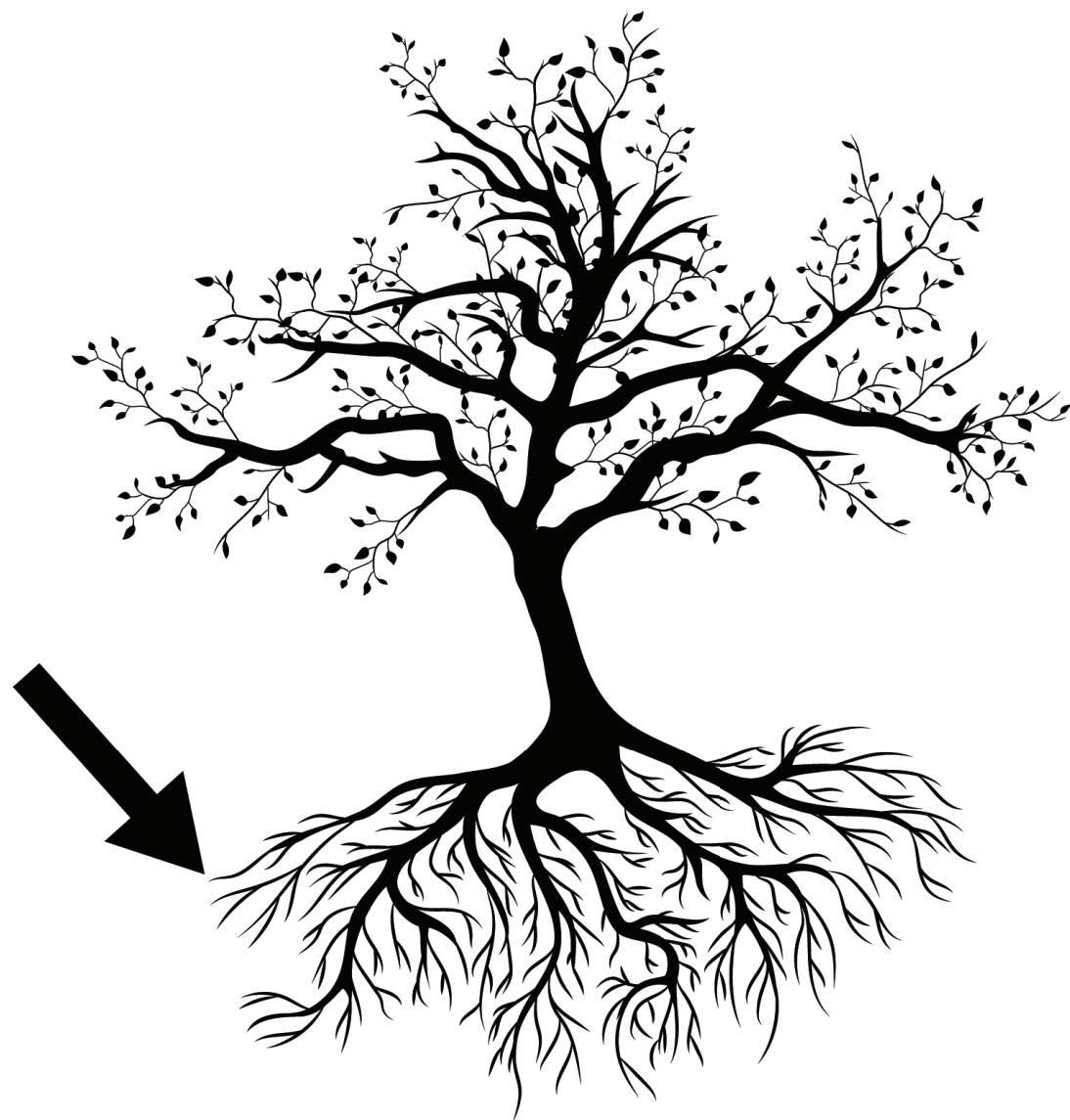

root

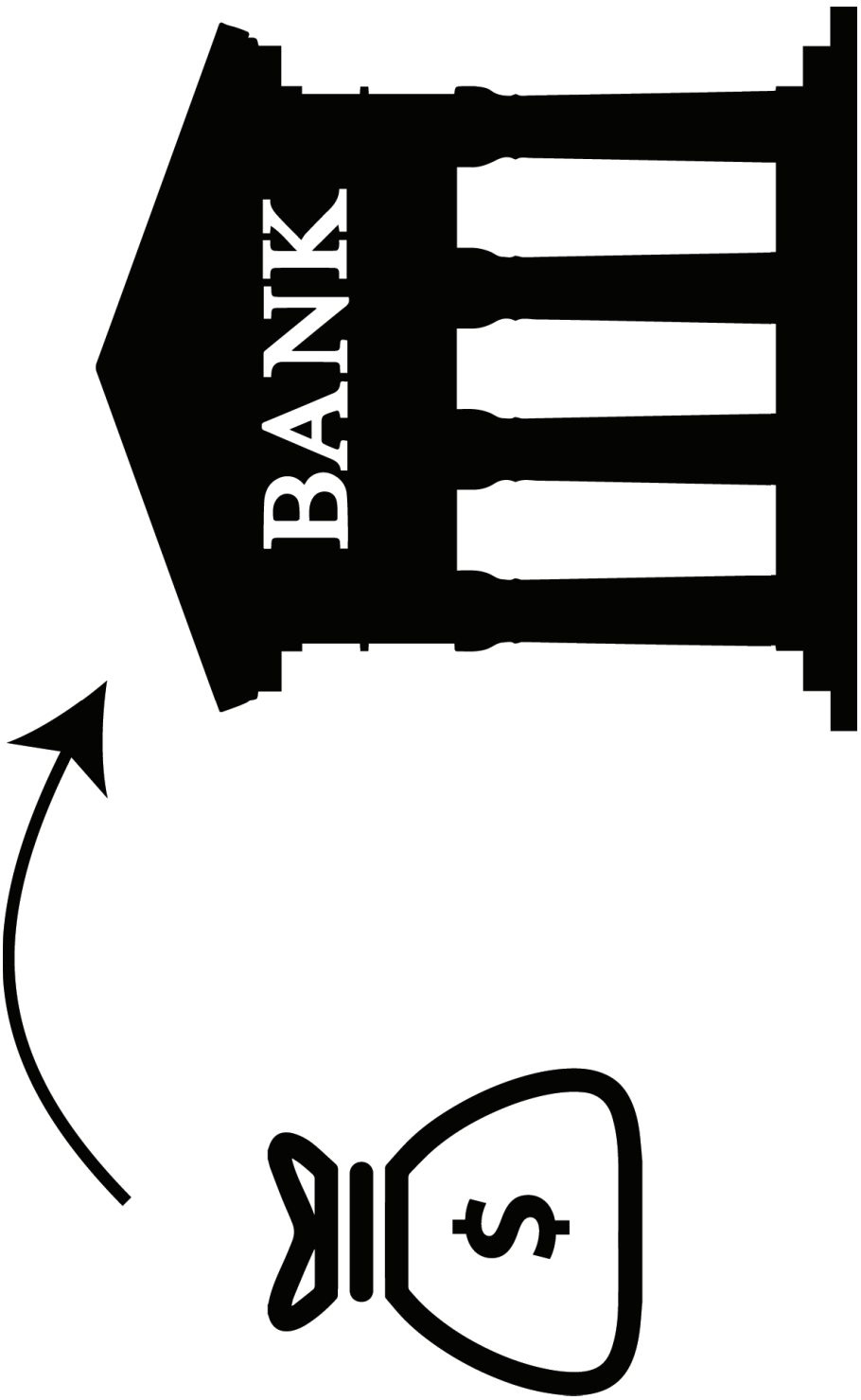

save

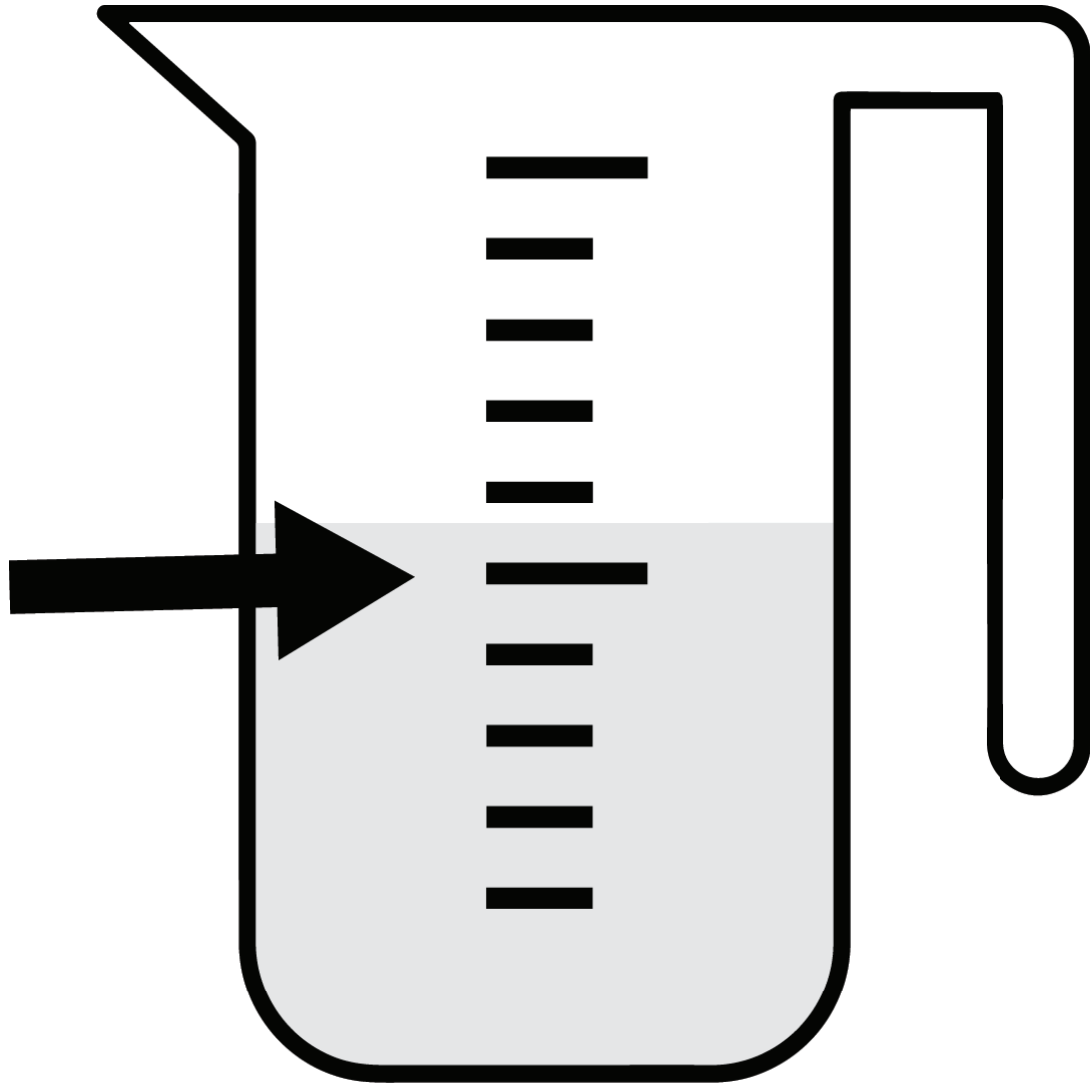

half

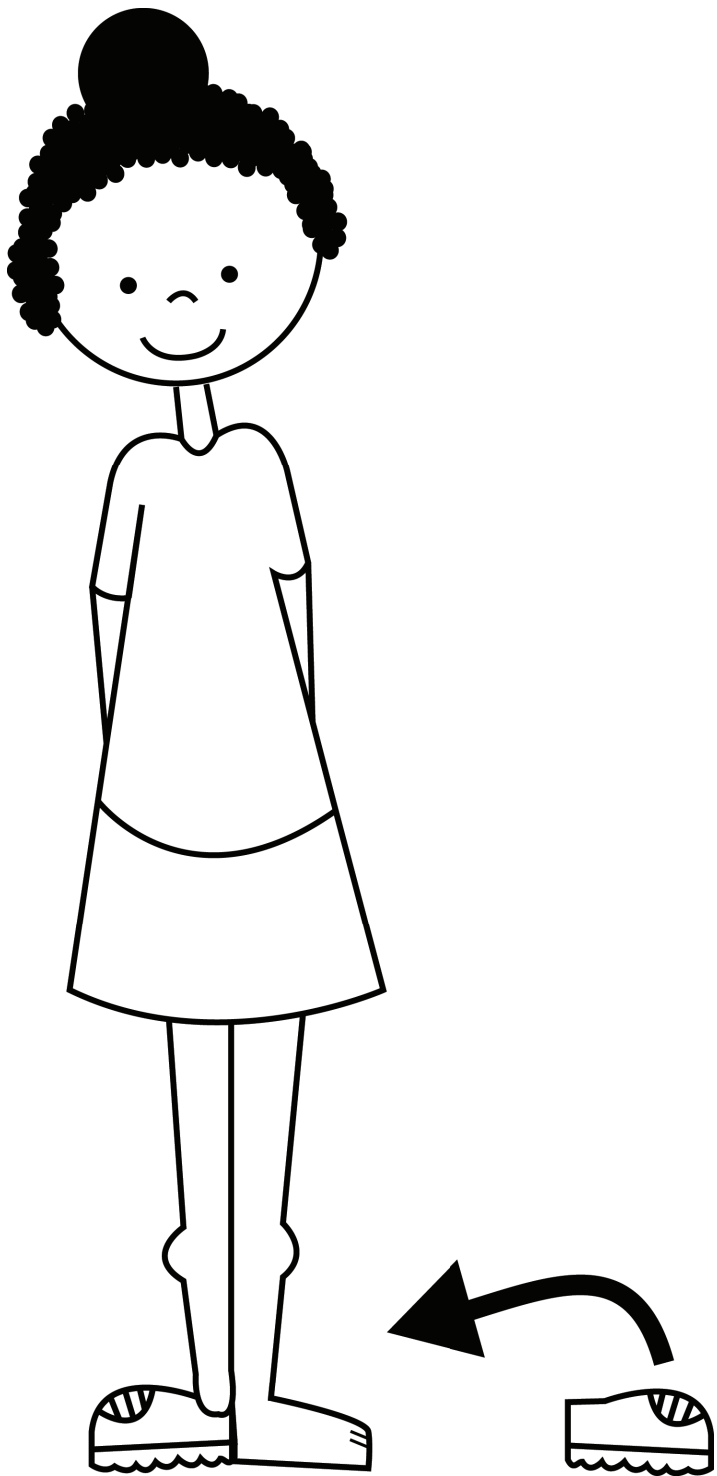

belong

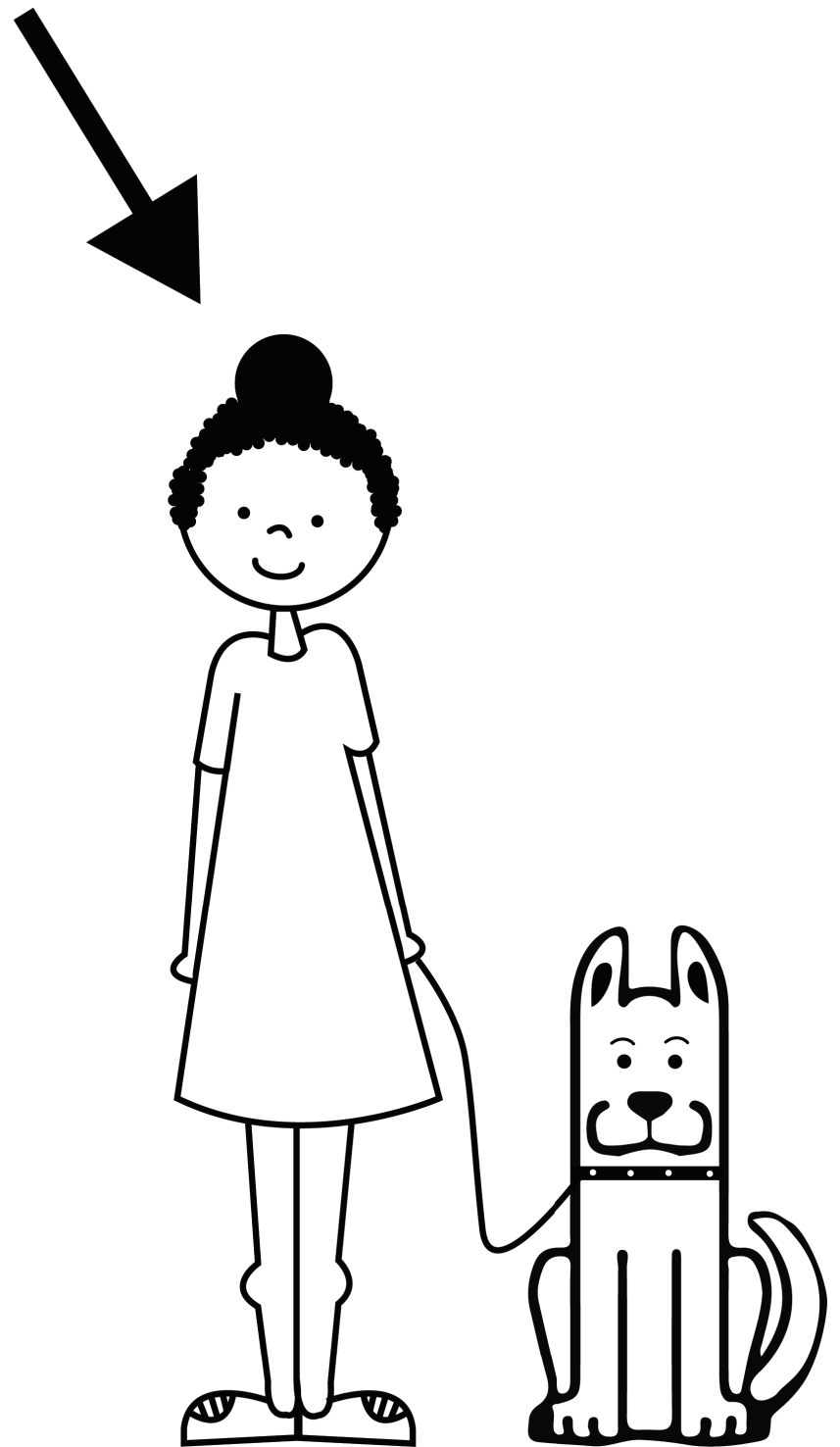

owner

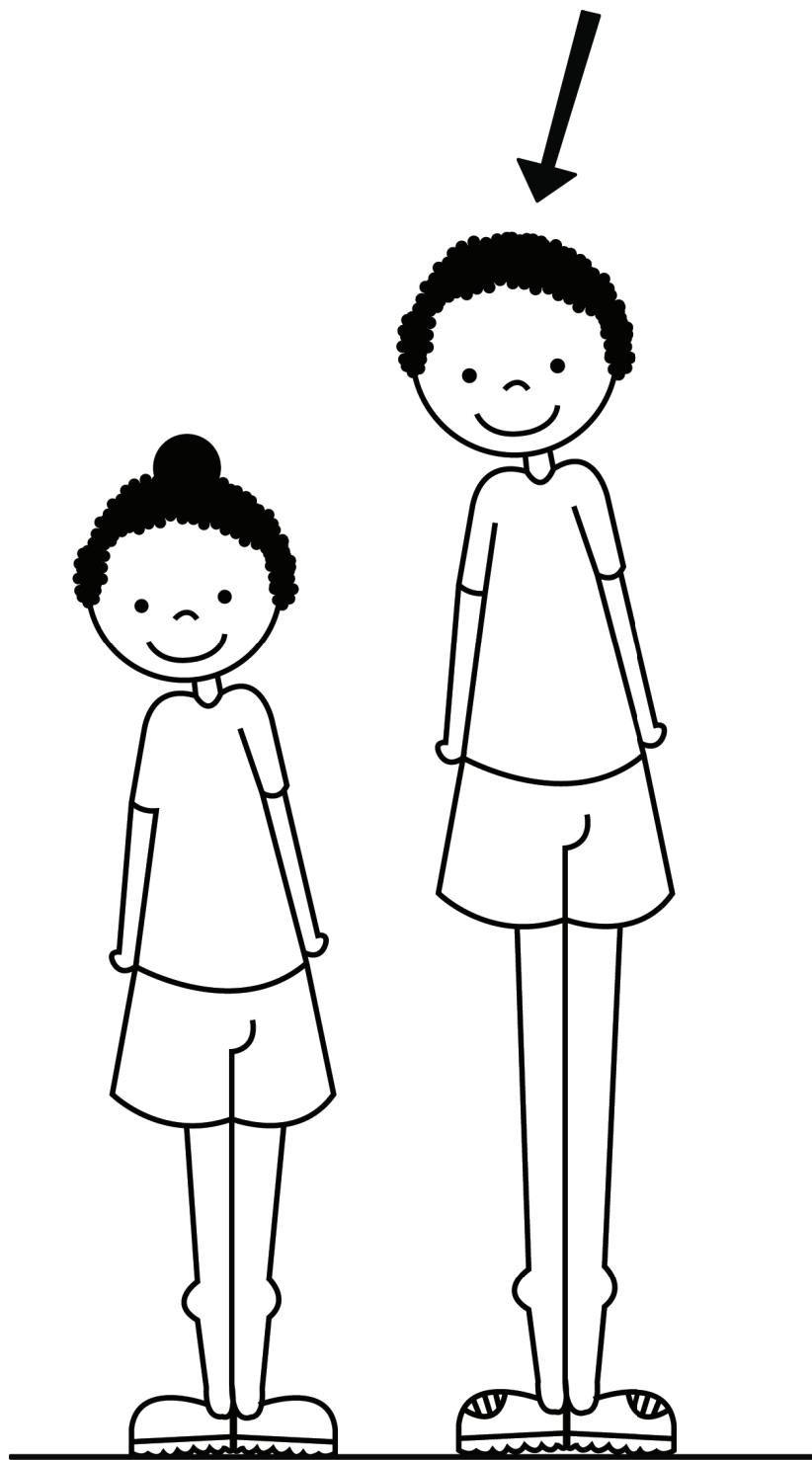

taller

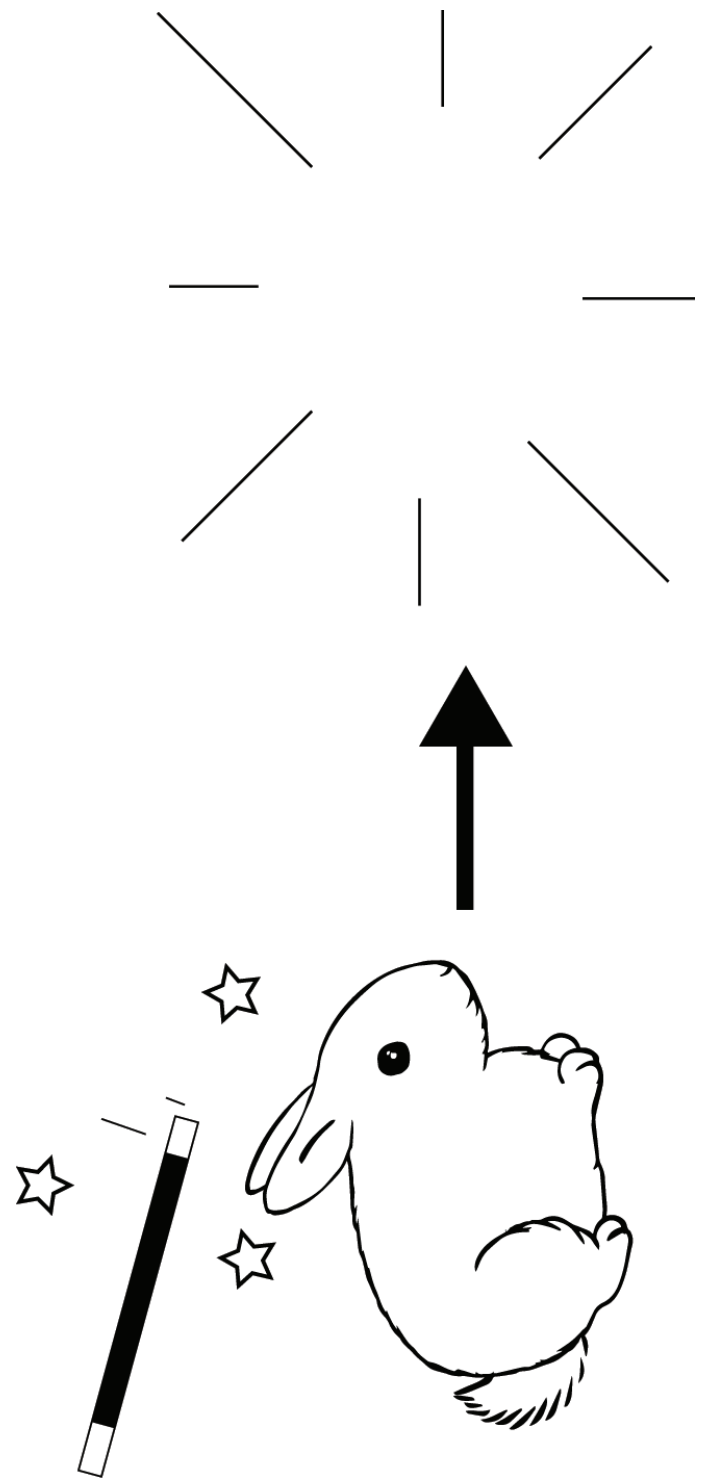

disappear



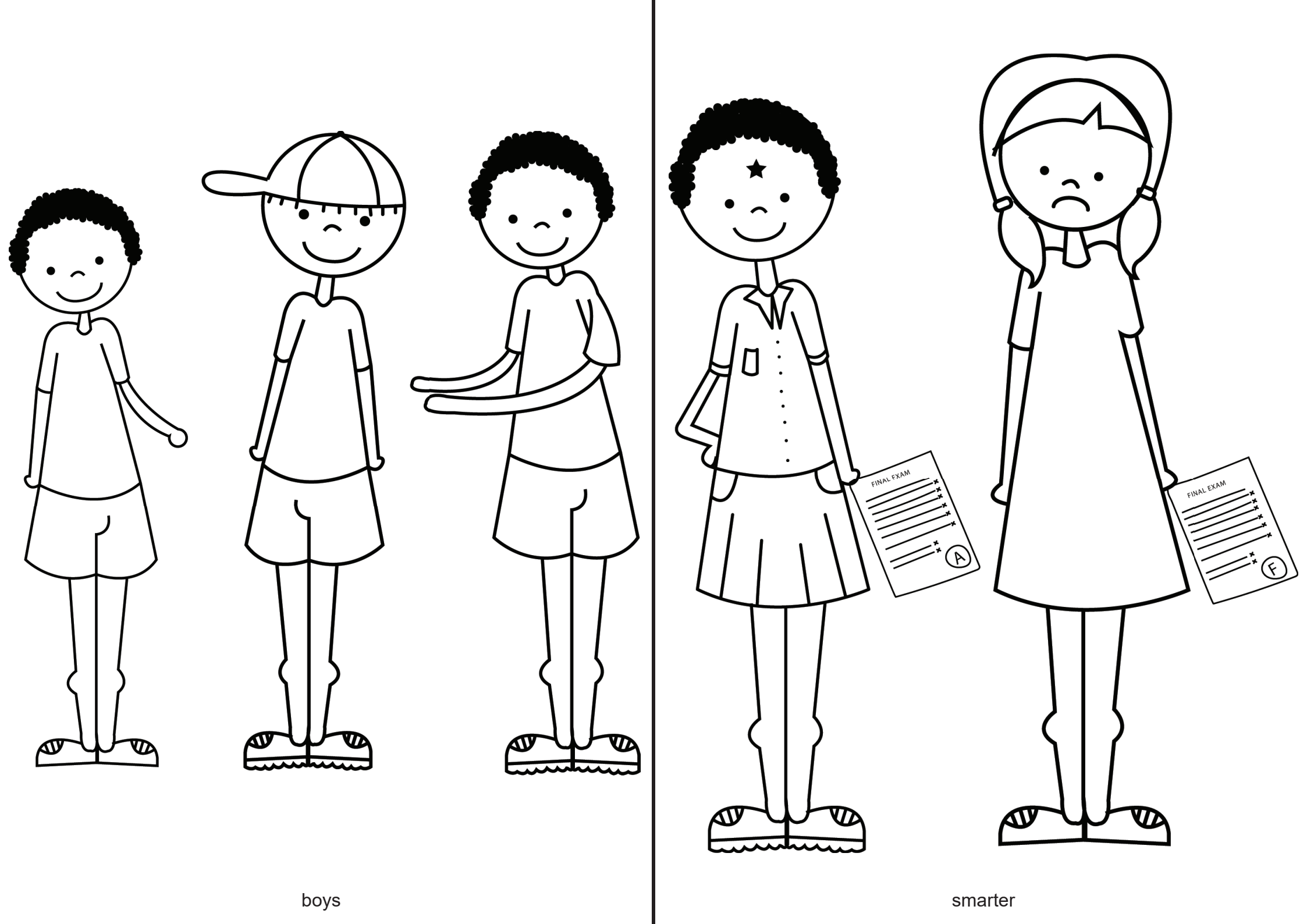

boys

smarter

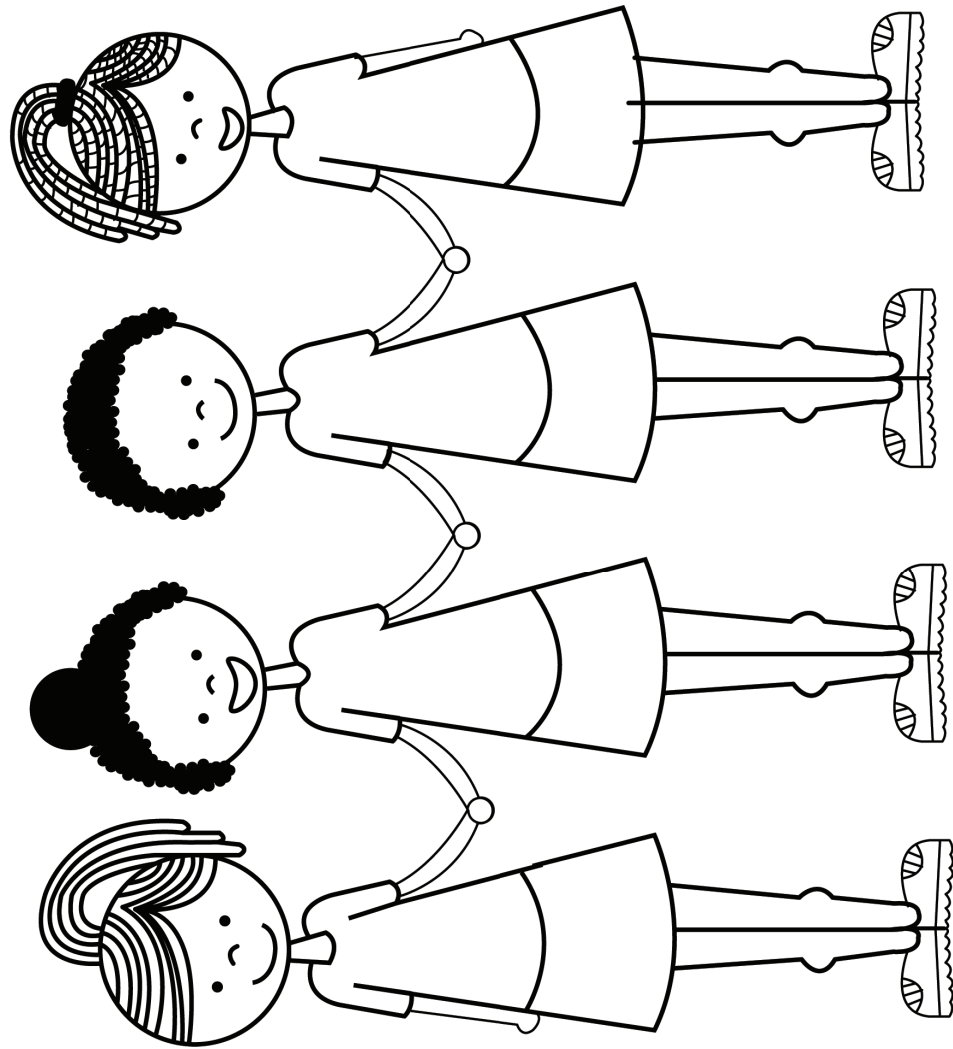

girls

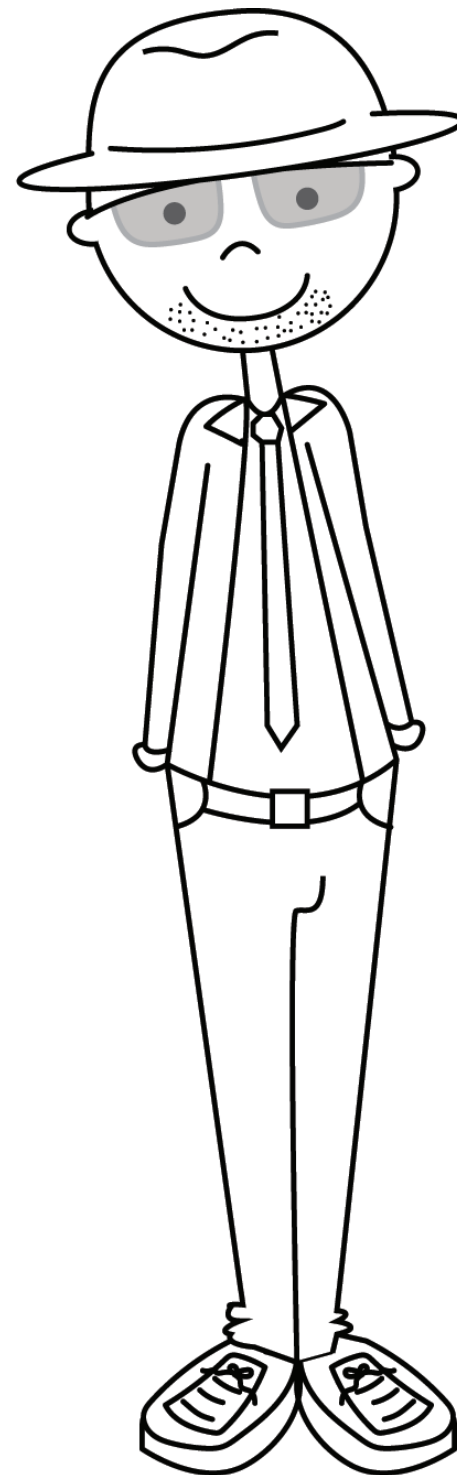
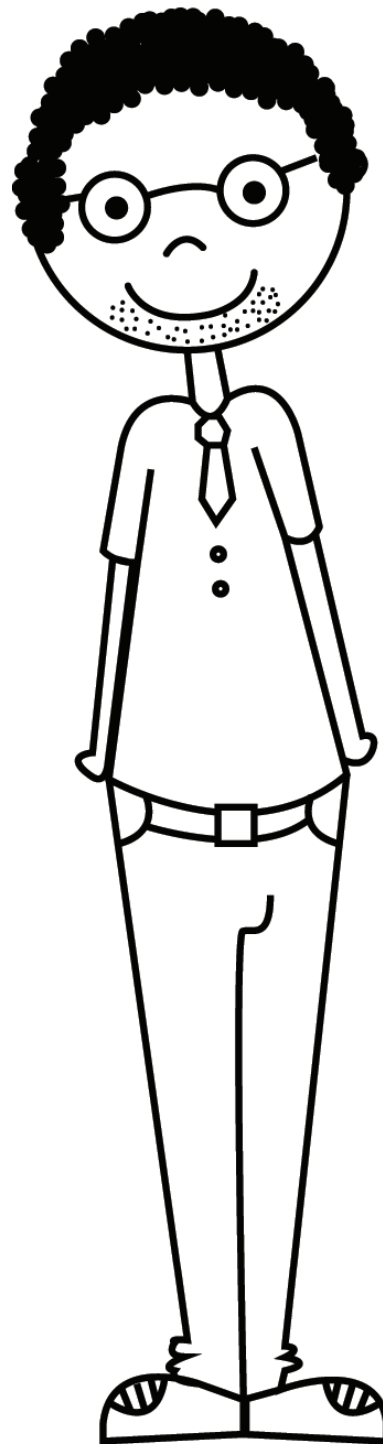

men



ignore

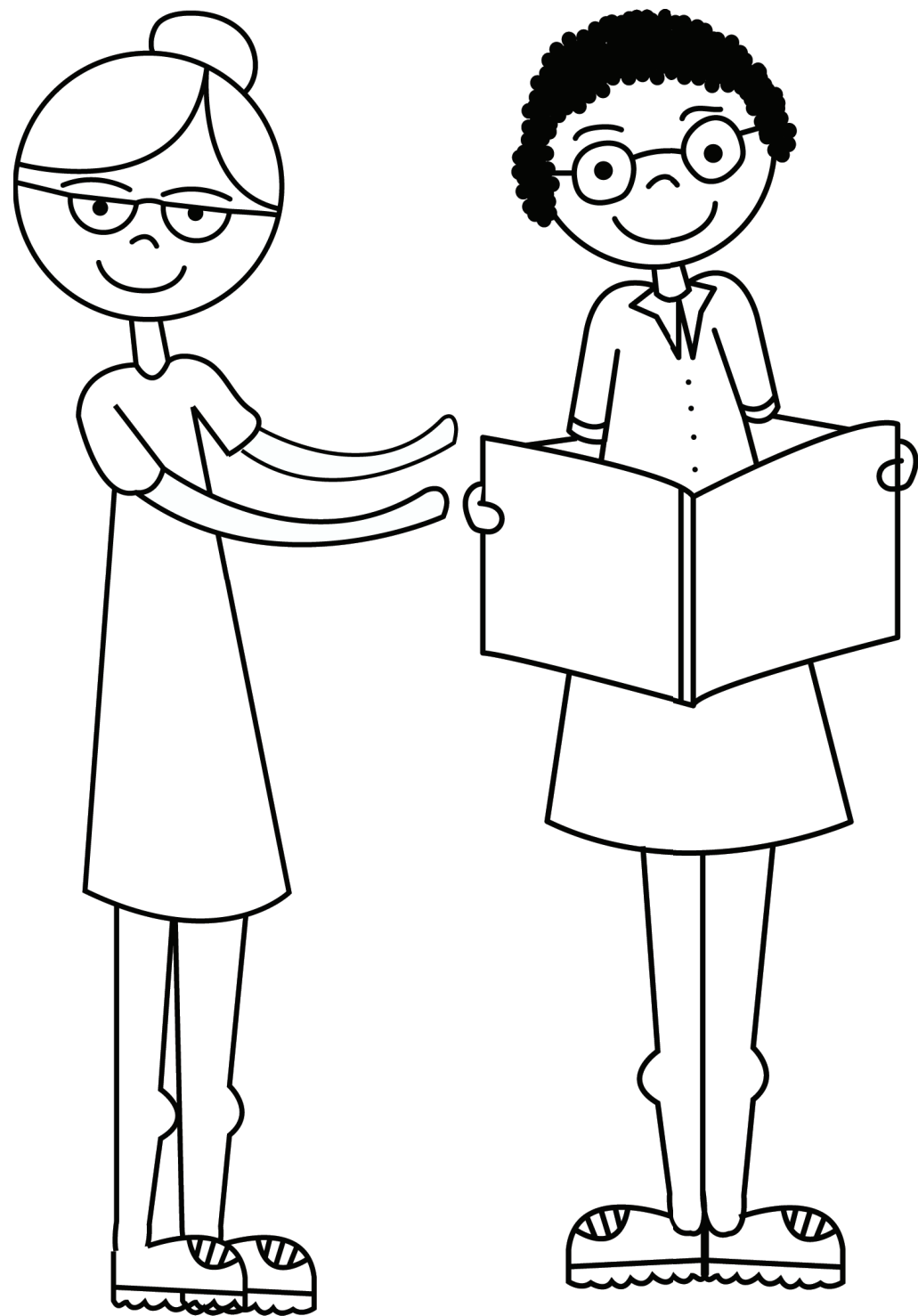

women

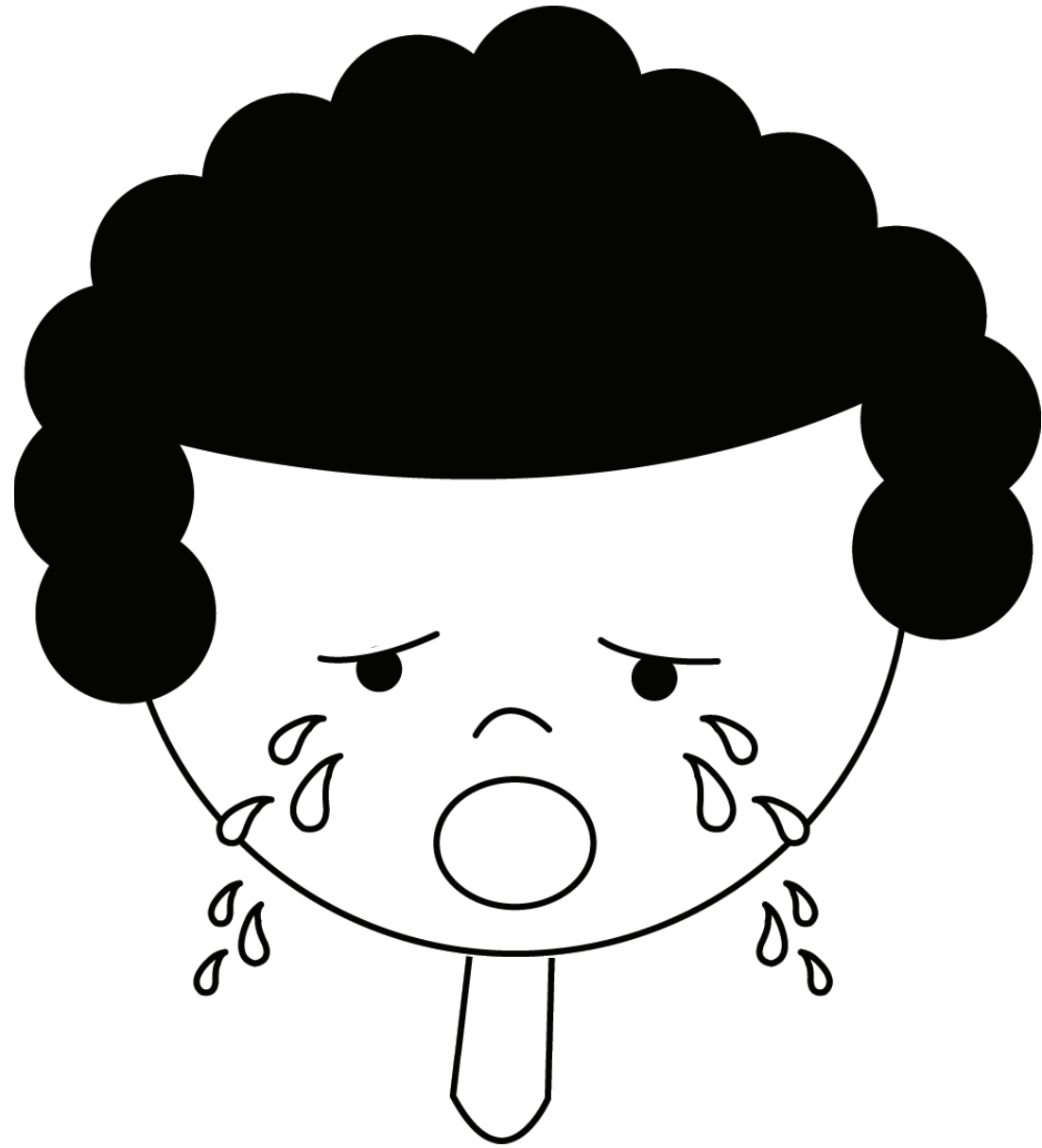

cry

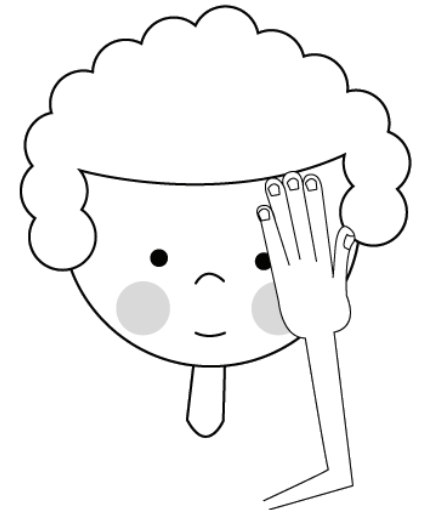
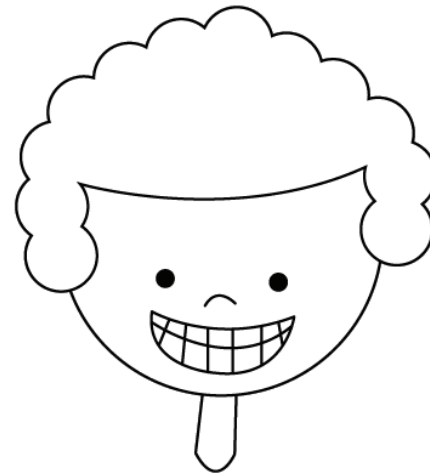
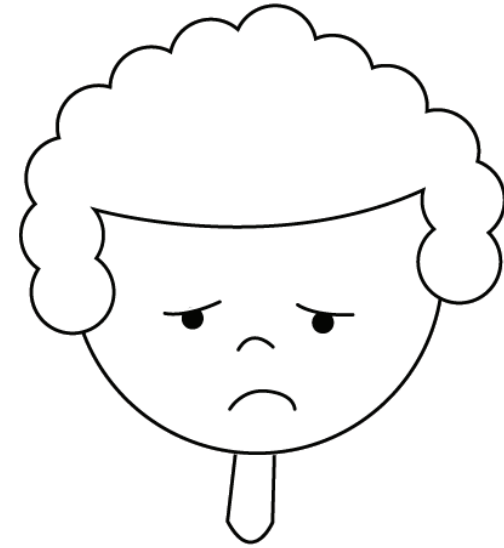
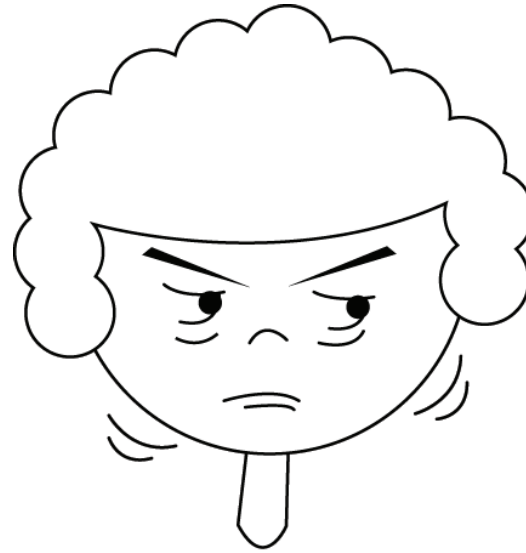

feelings

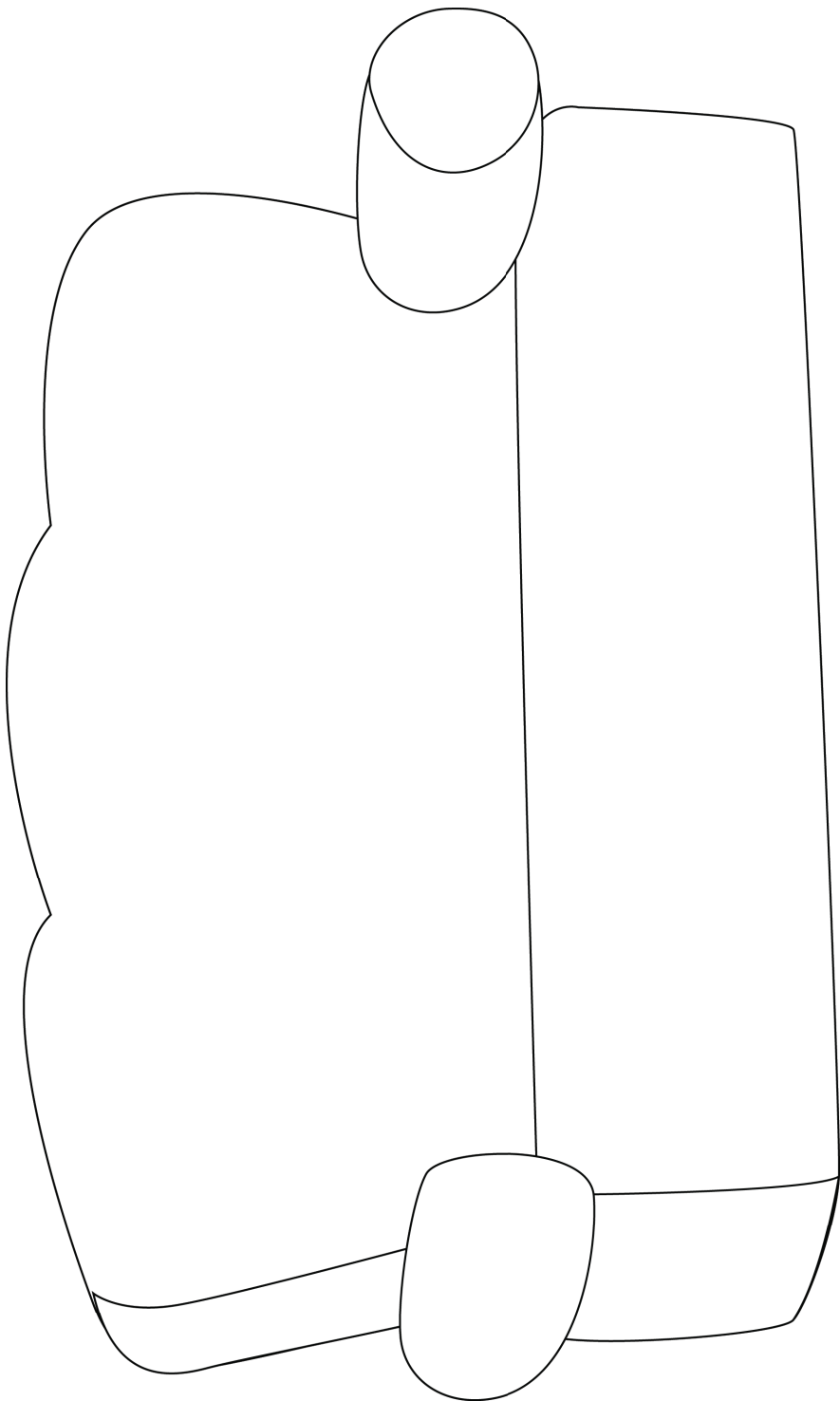

sofa

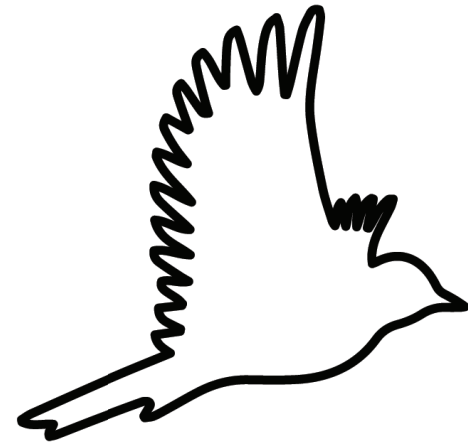
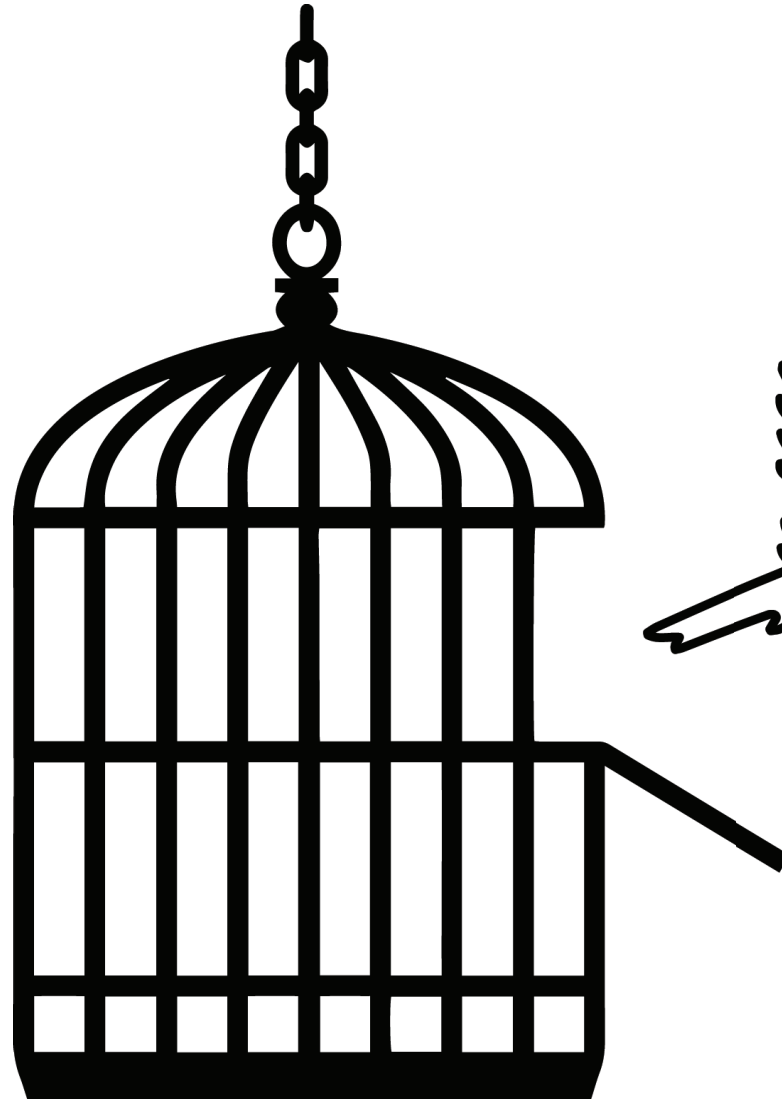

free



uncomfortable

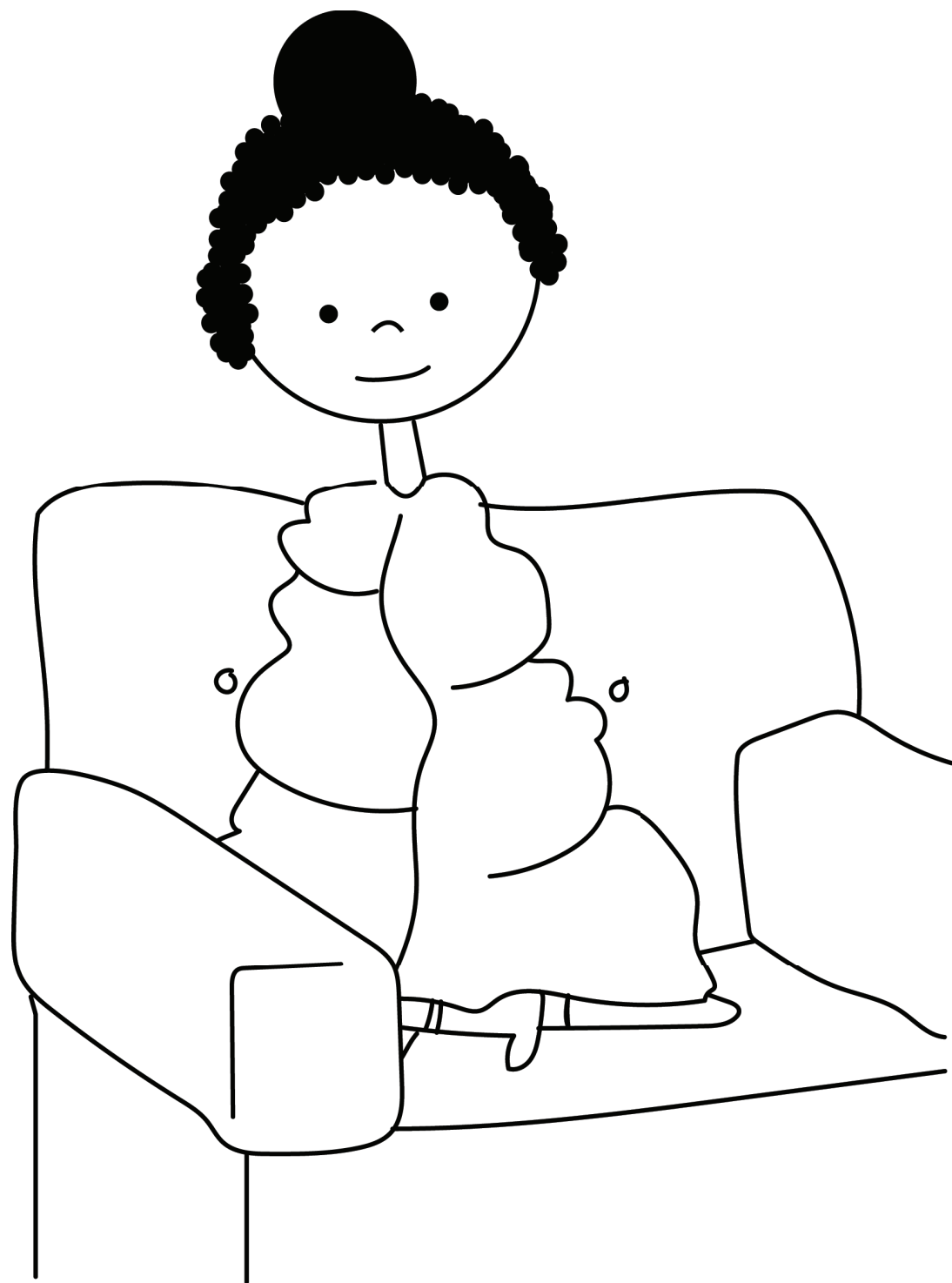

comfortable



unhappy

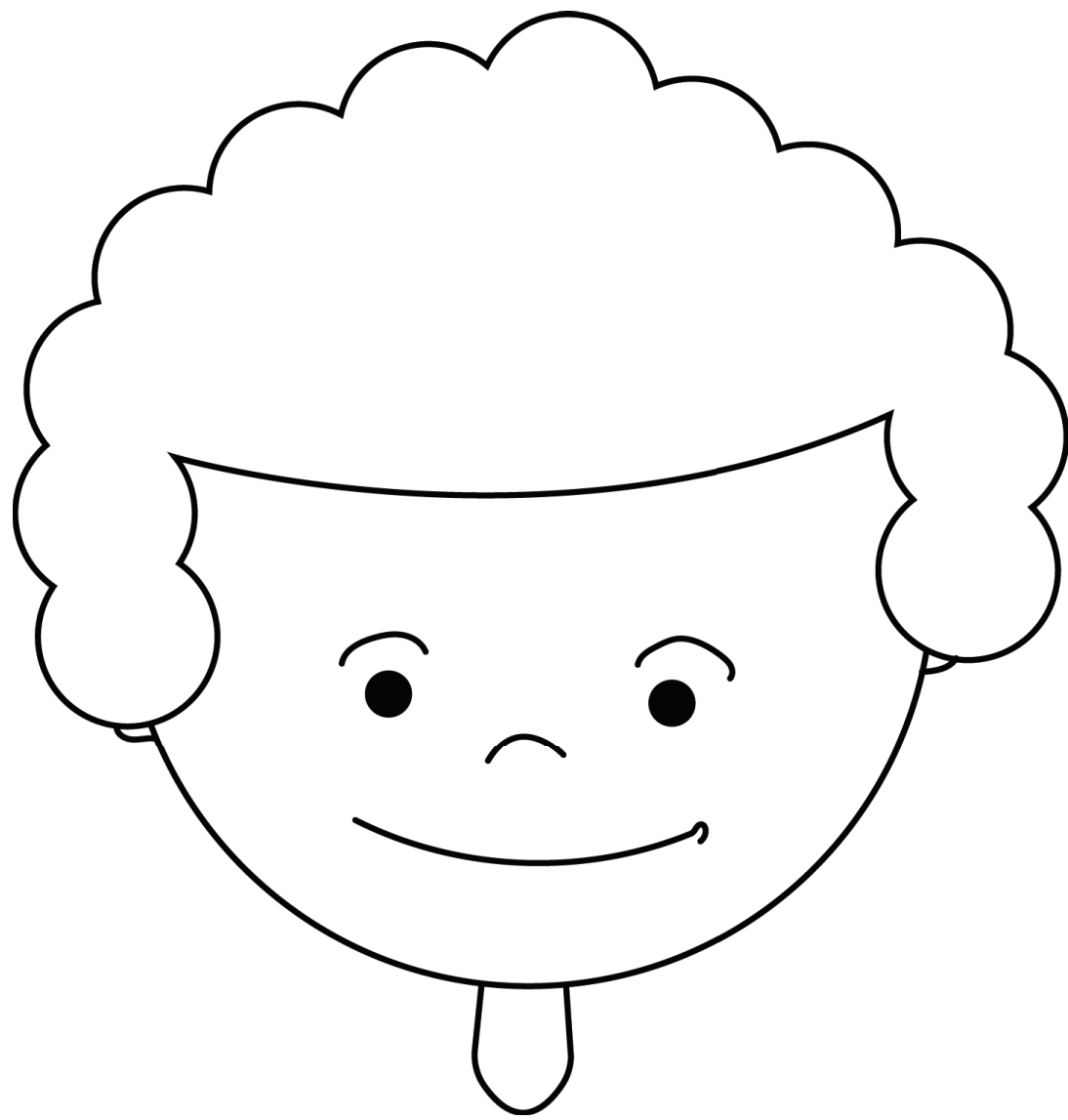

happy



winter

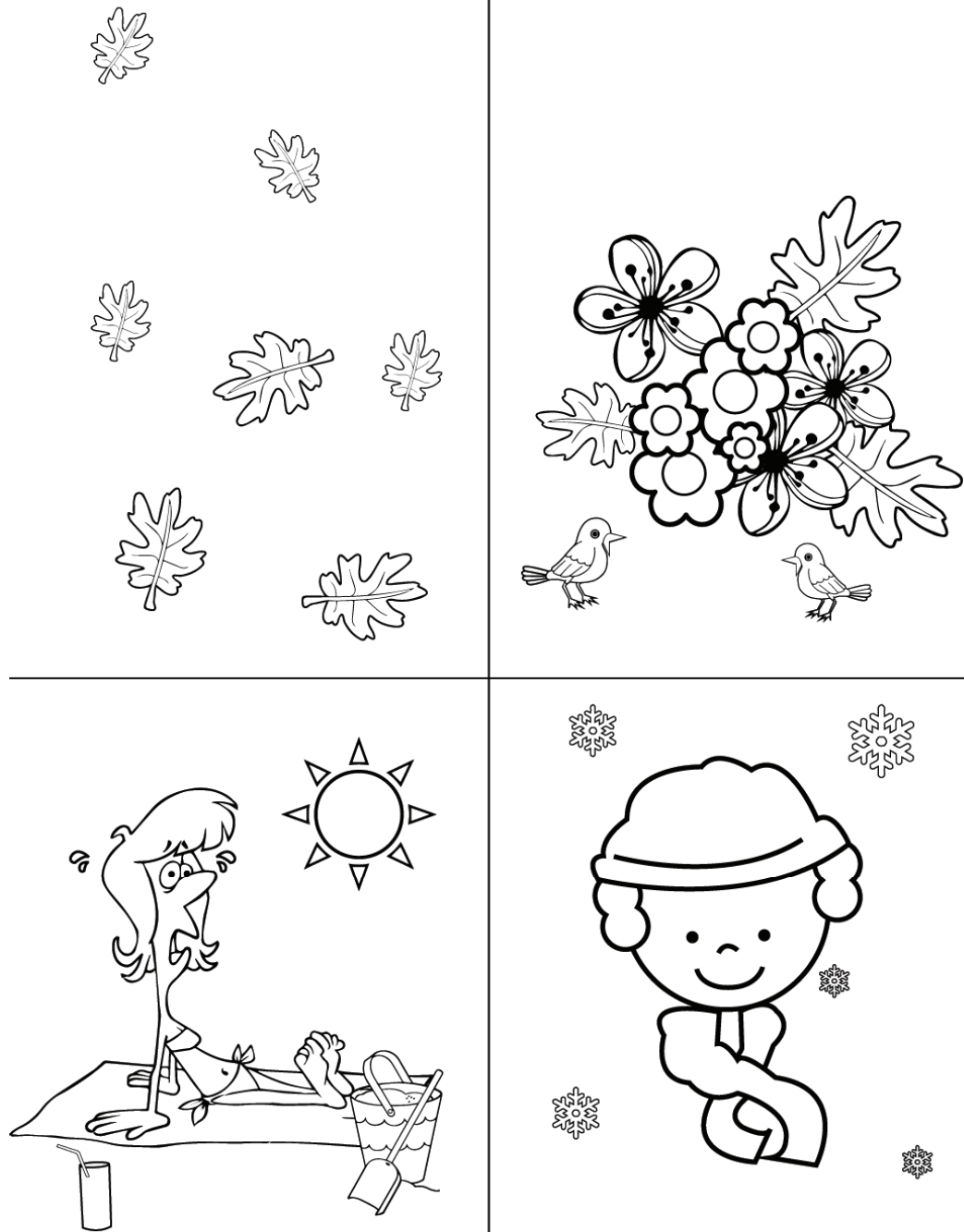

season





jacket

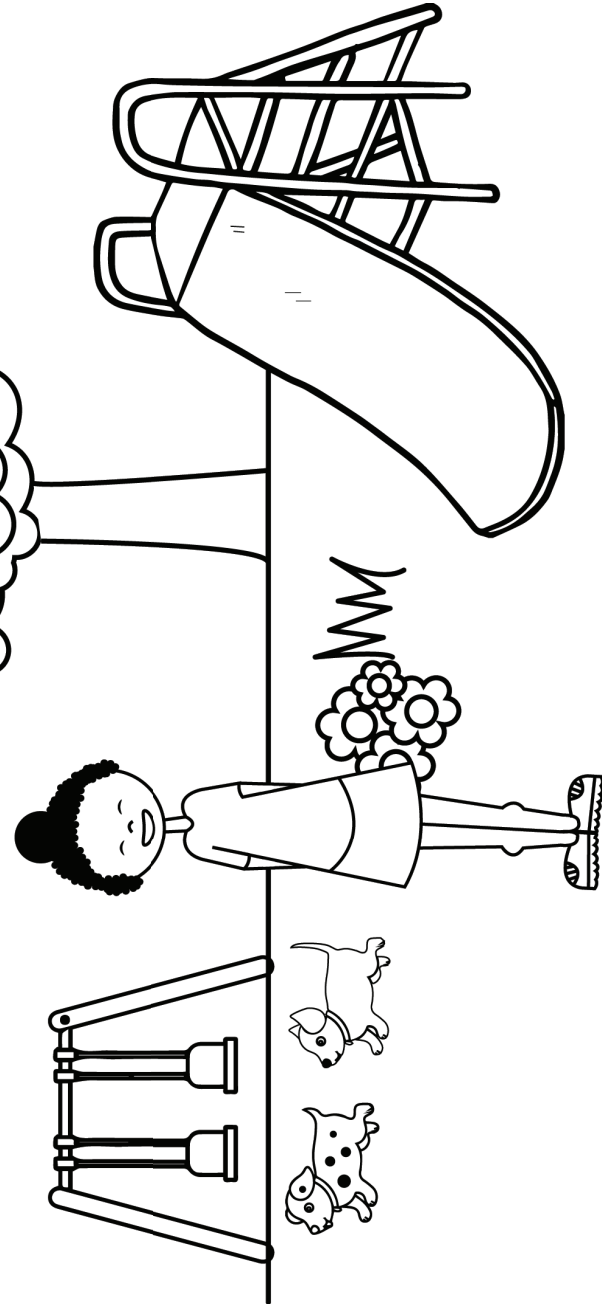
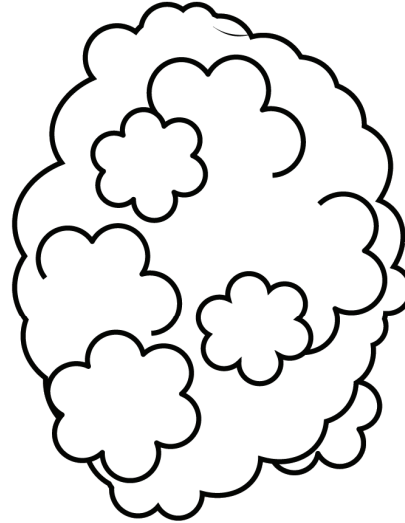
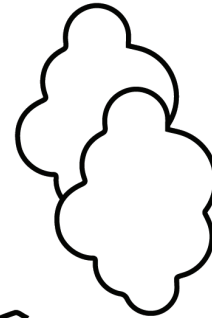
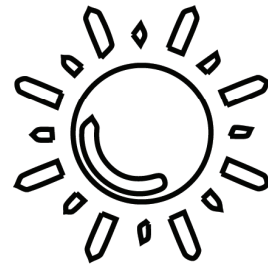

summer

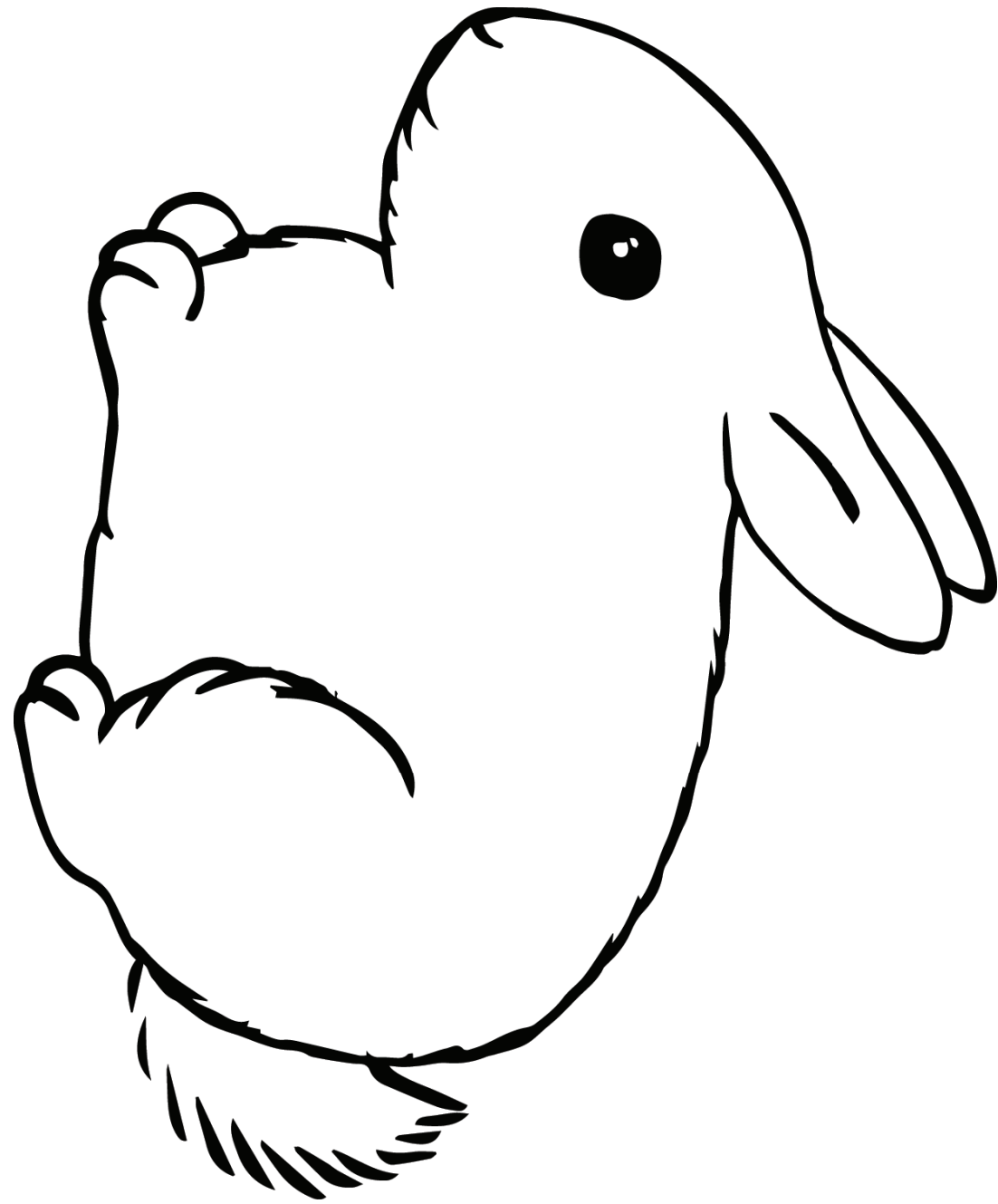

fluffy



cold

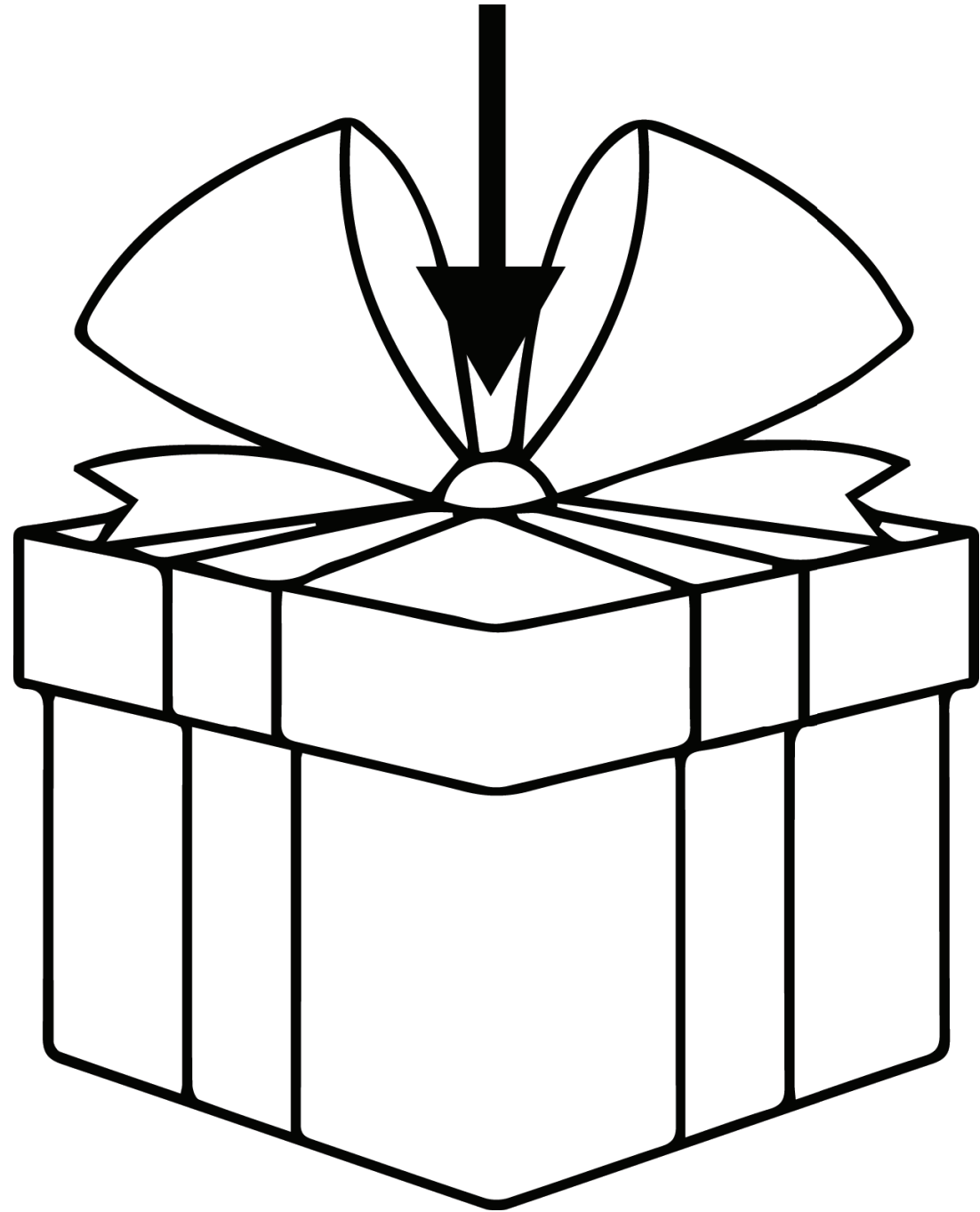

tight

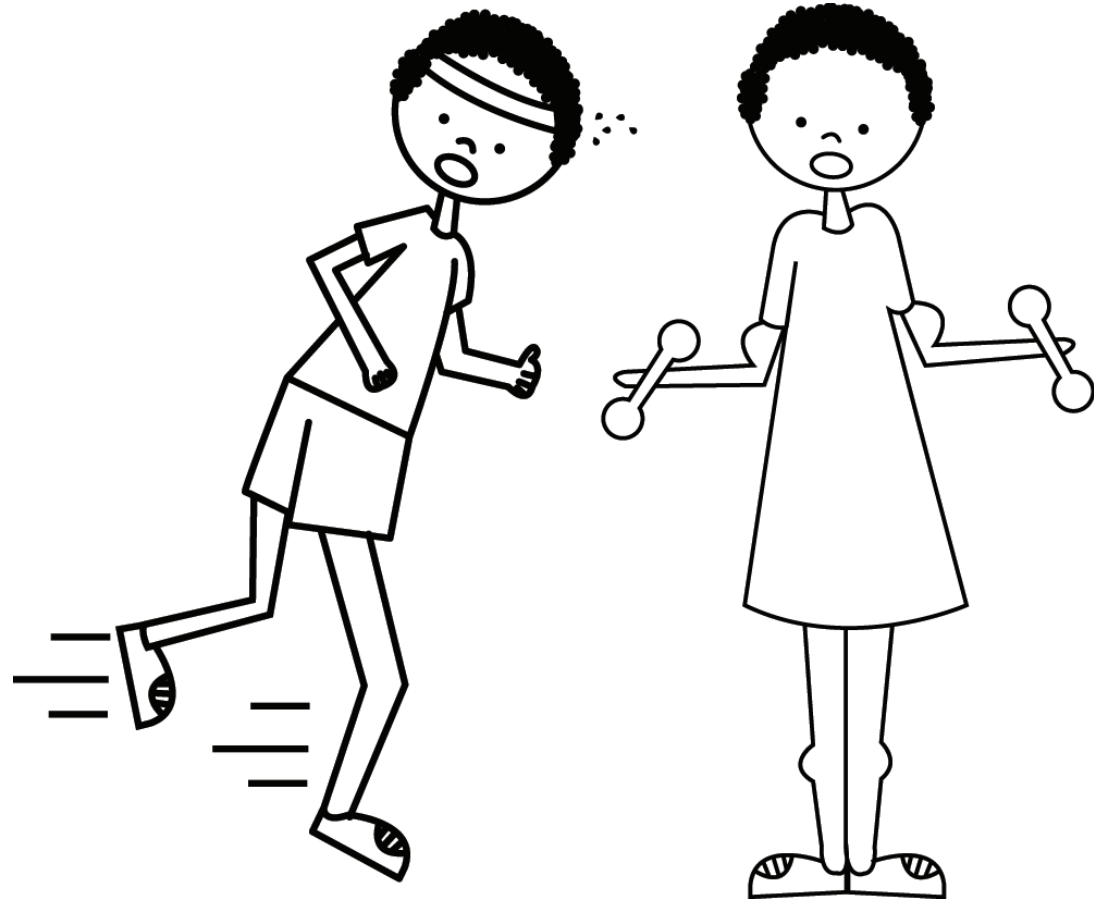

fit

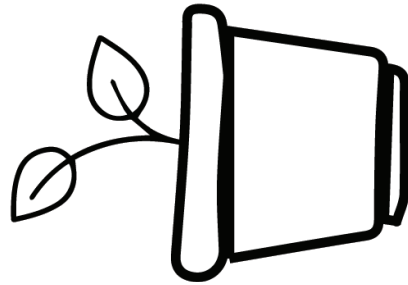
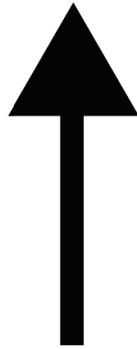
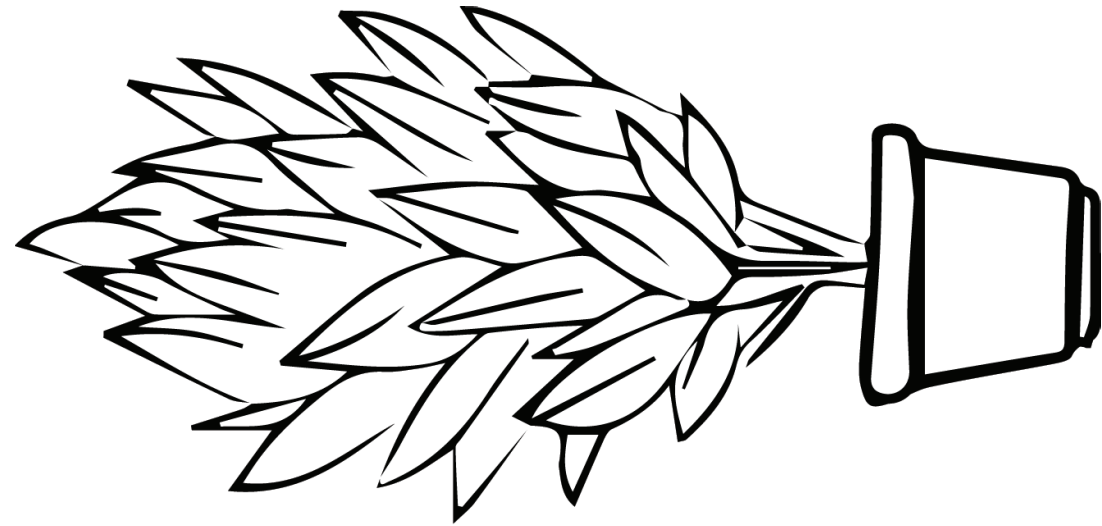

grow

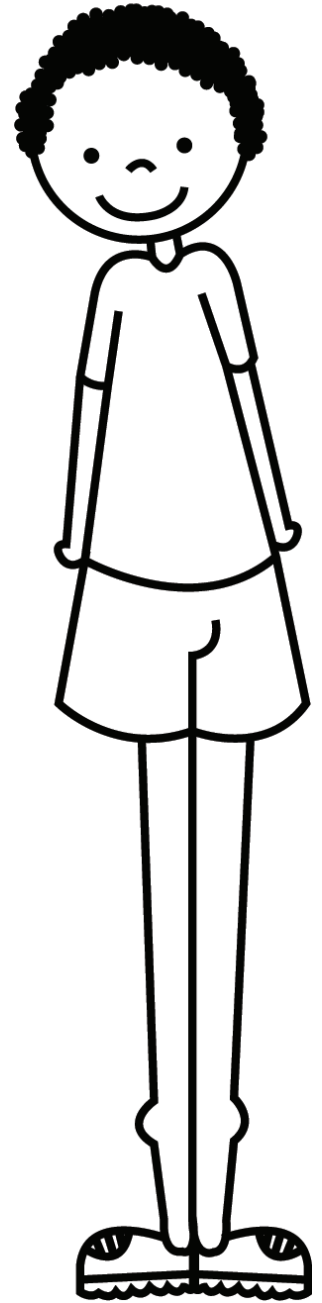
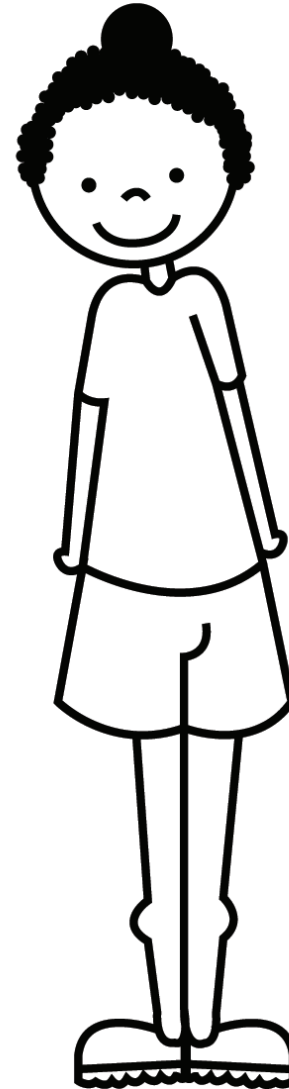

short



fight

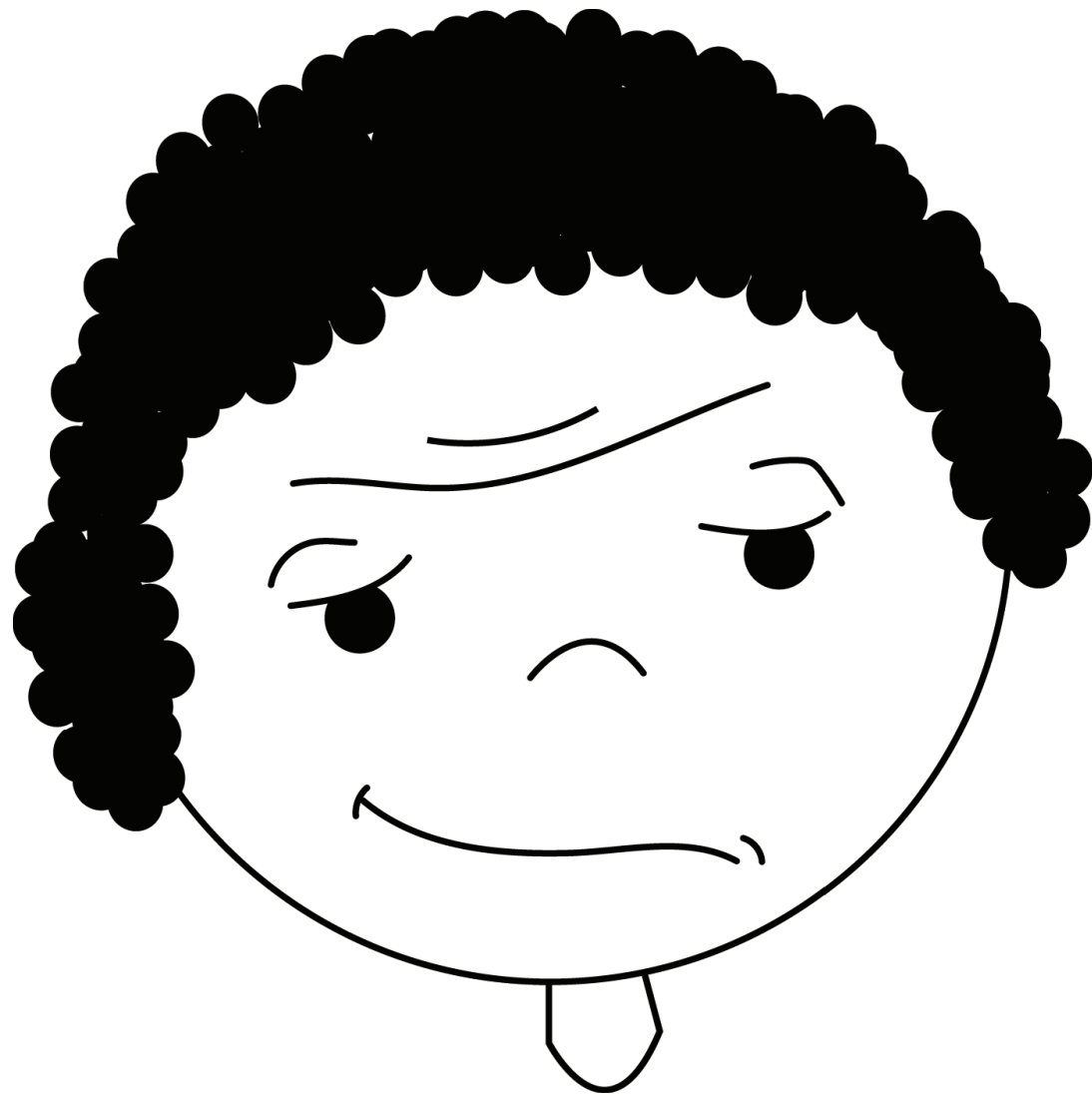

confused

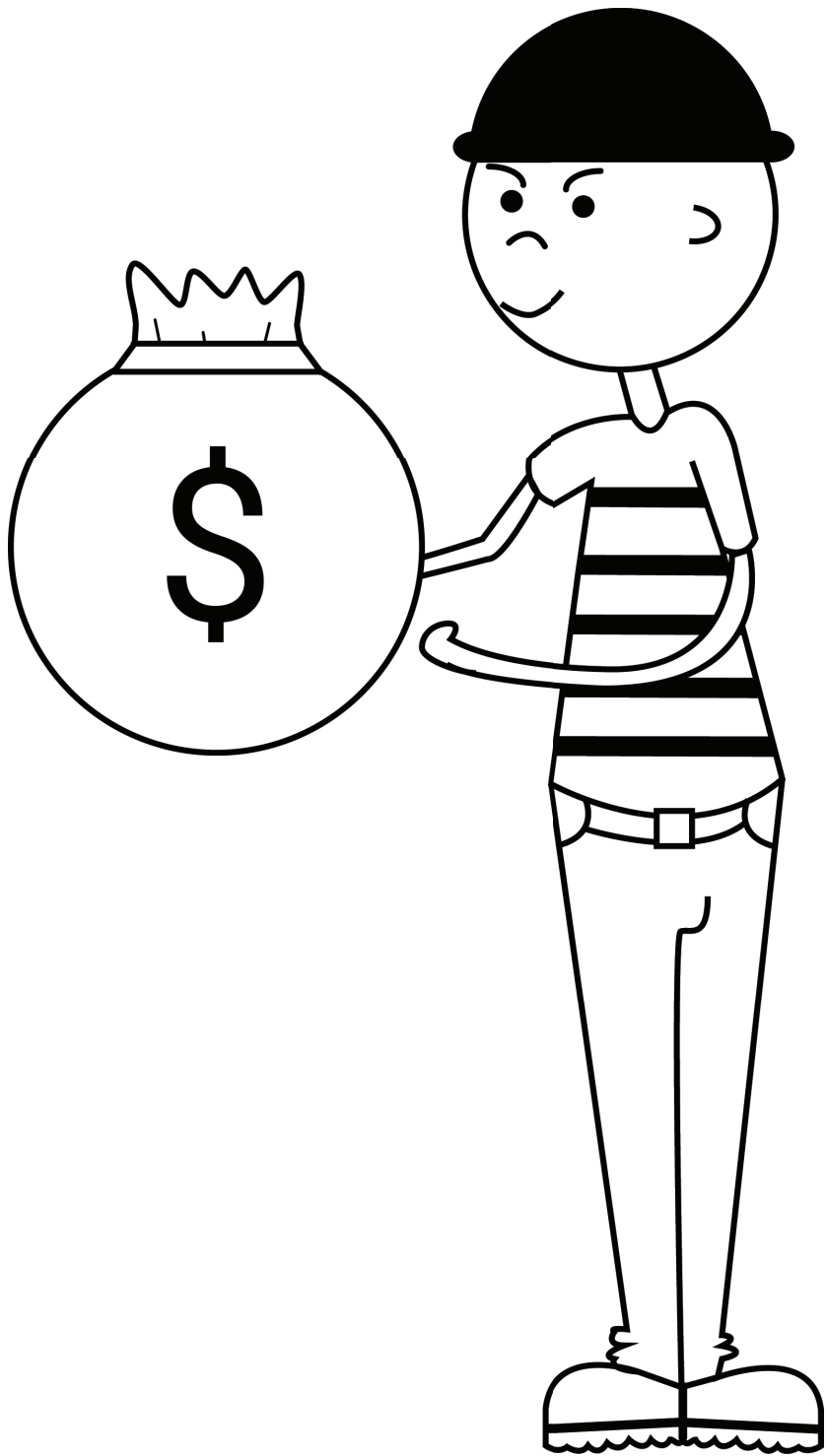

thief

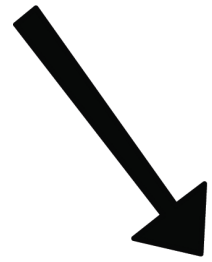

stolen

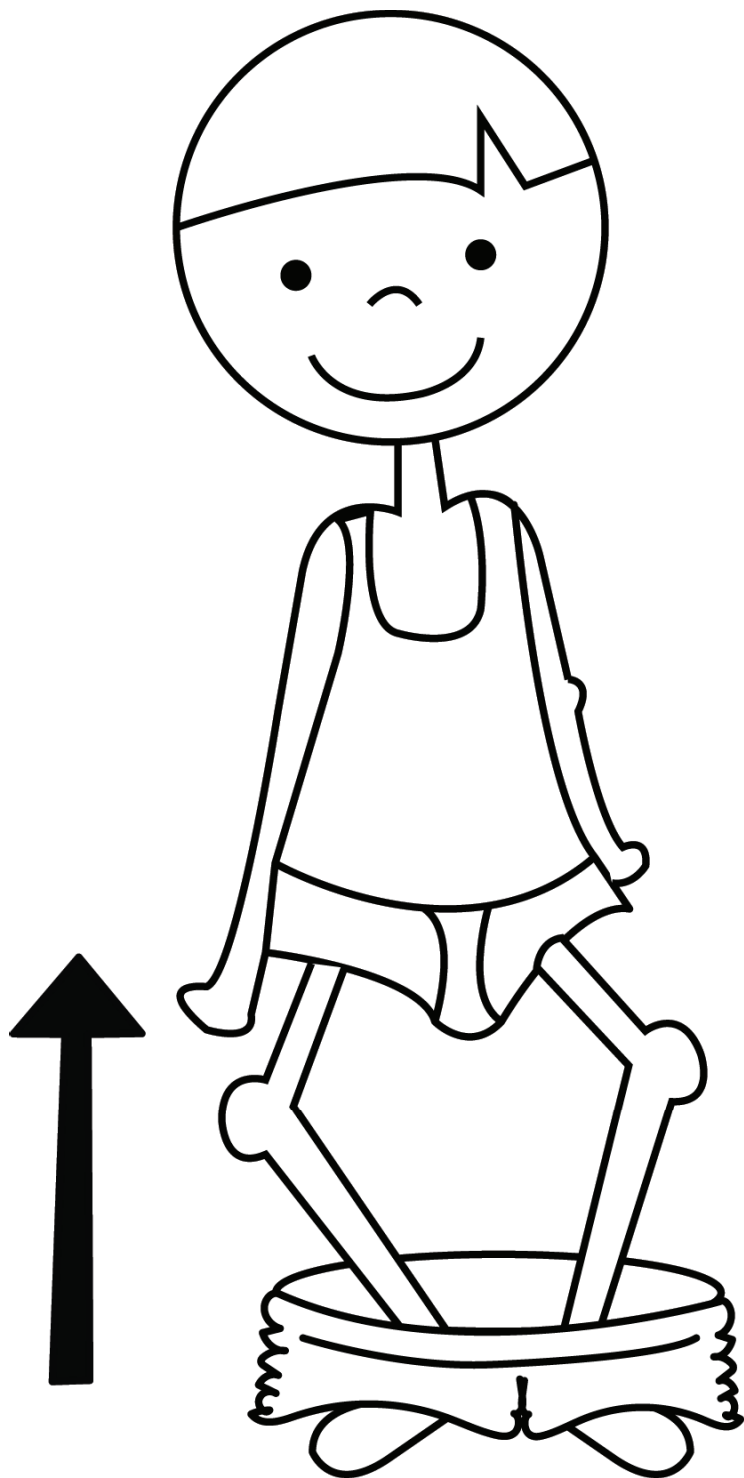

put on

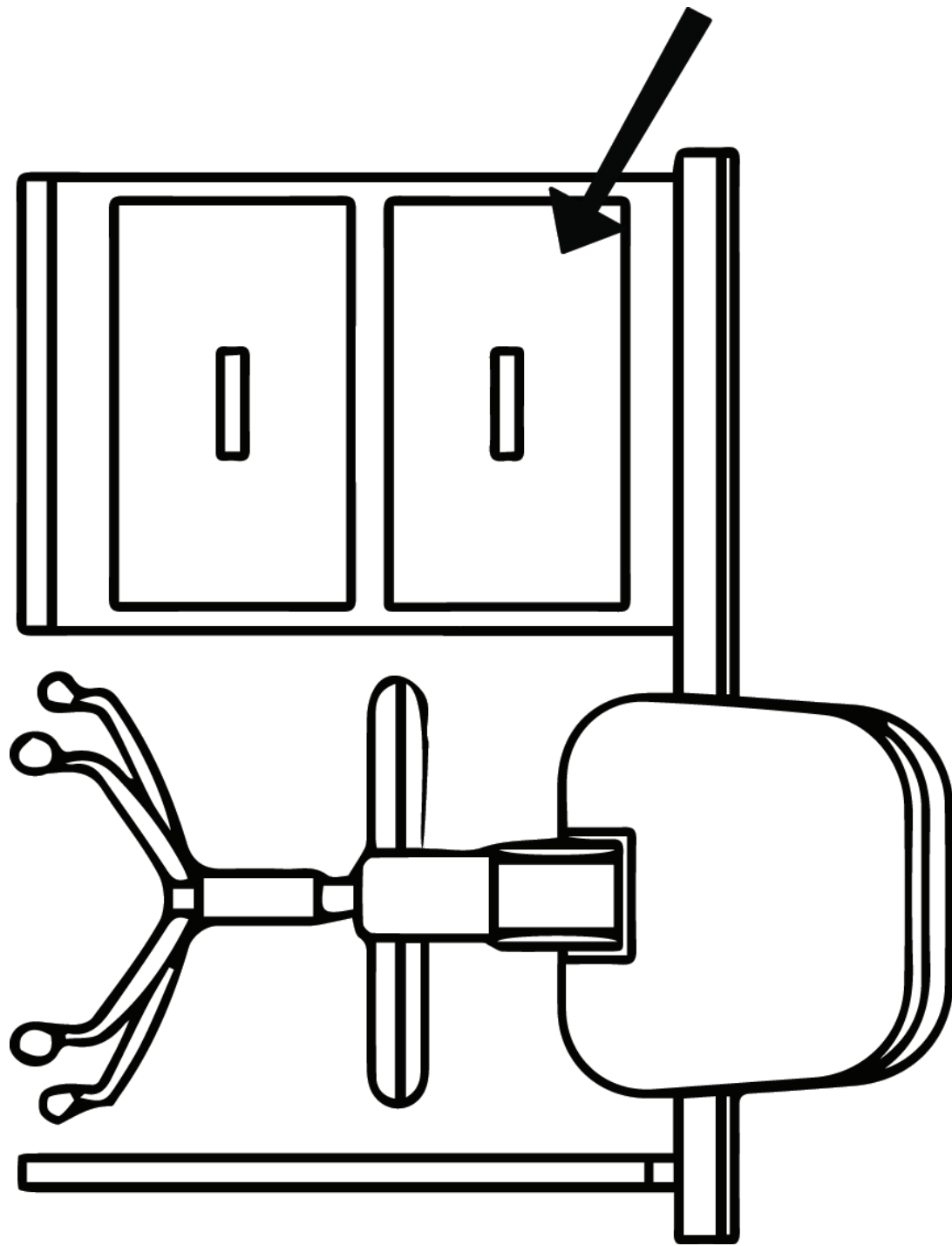

drawer

**2019**

**JAN**

**1**

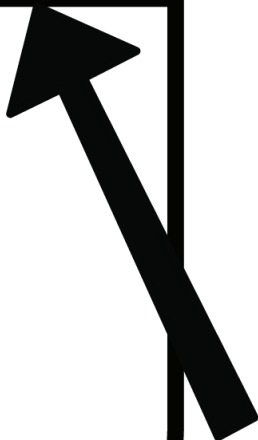

year

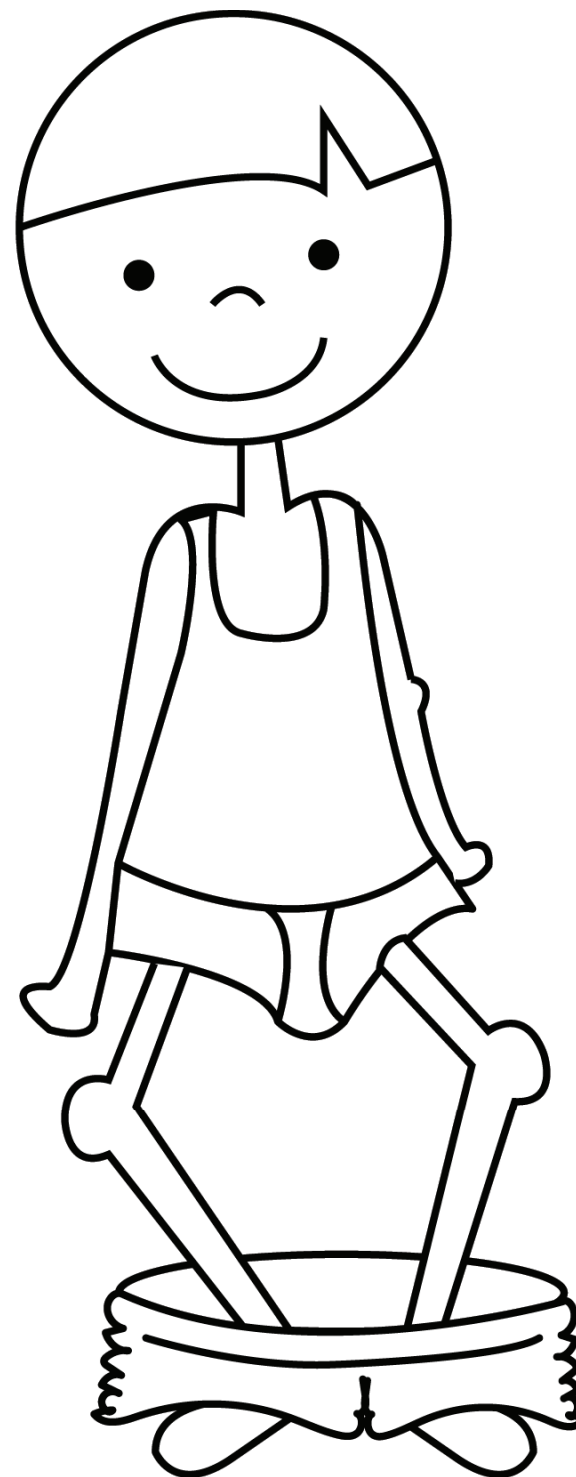

take off



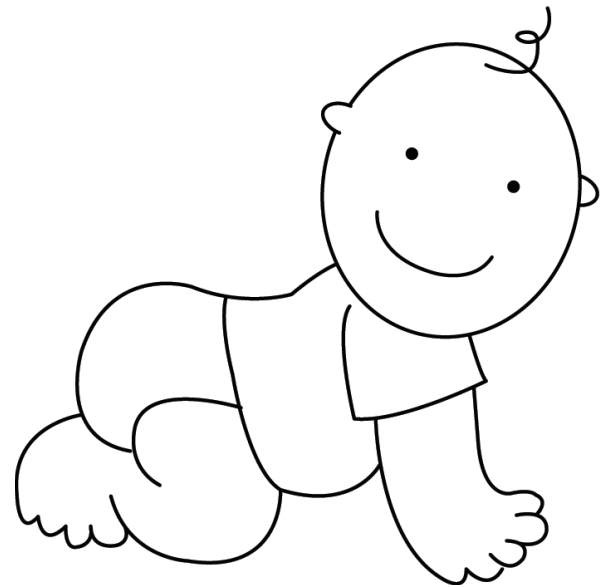
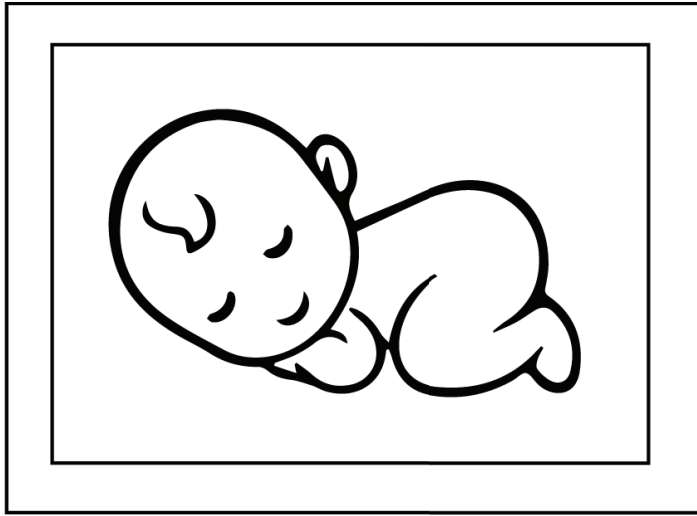
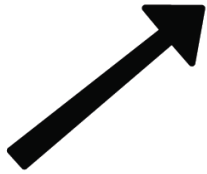

past

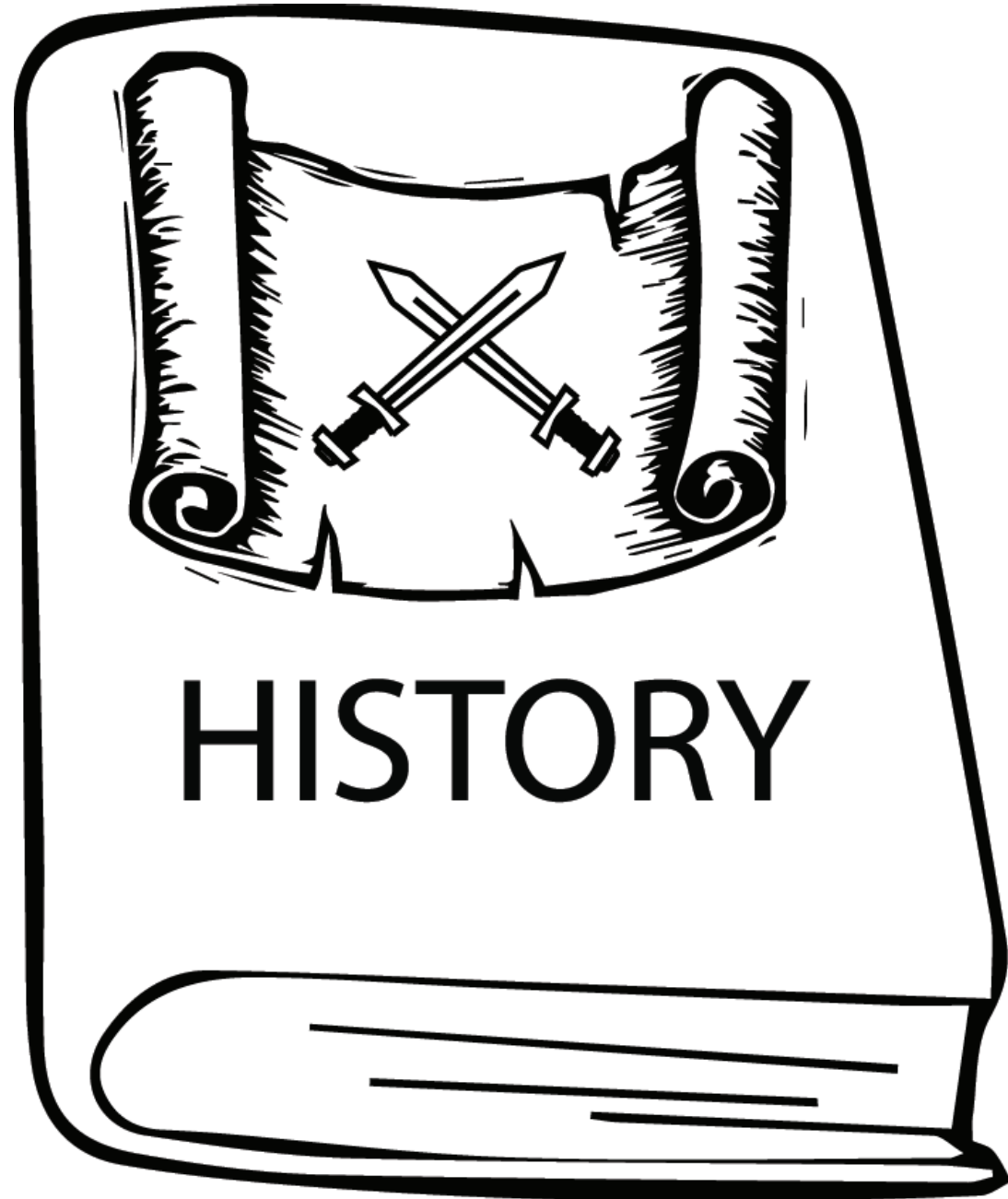

history

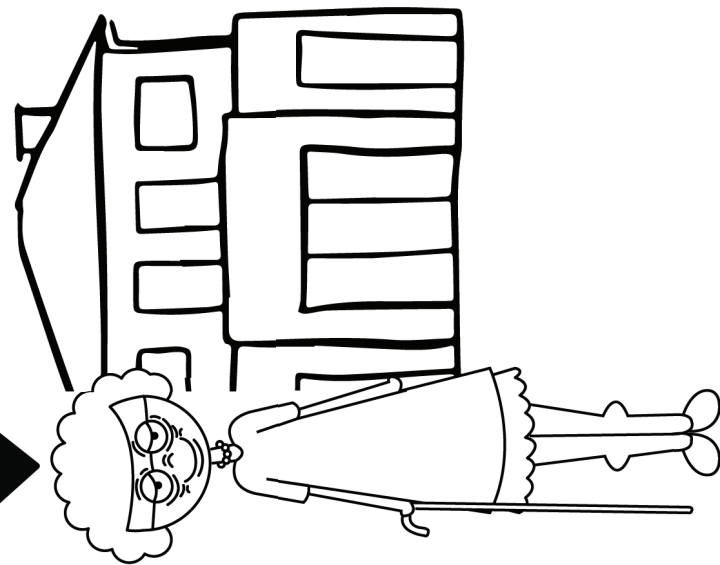
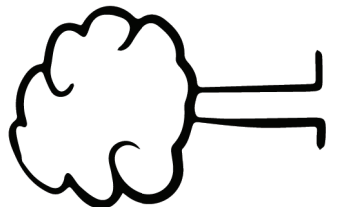
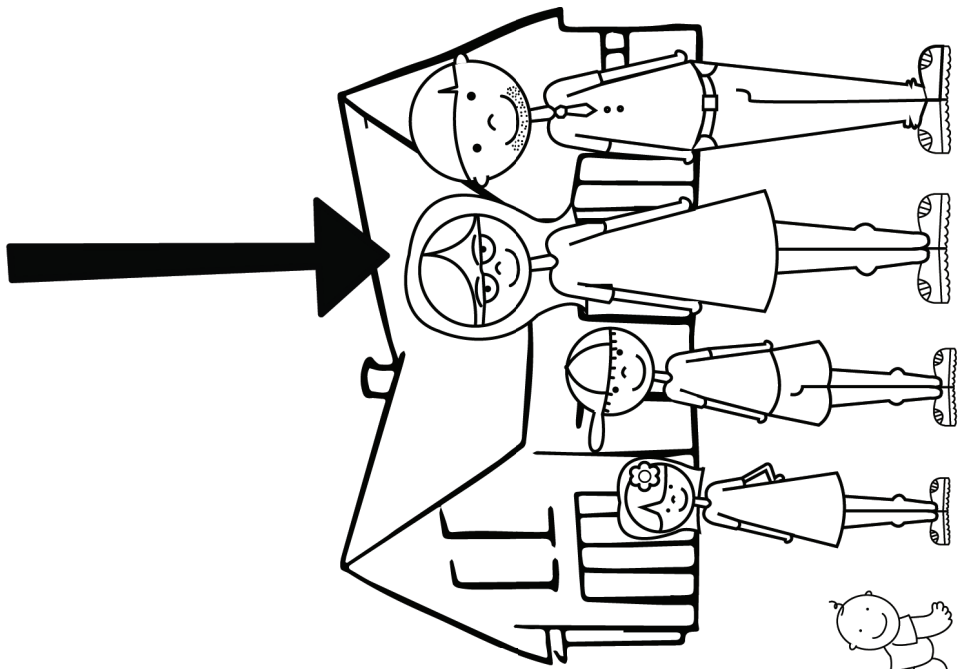

neighbour

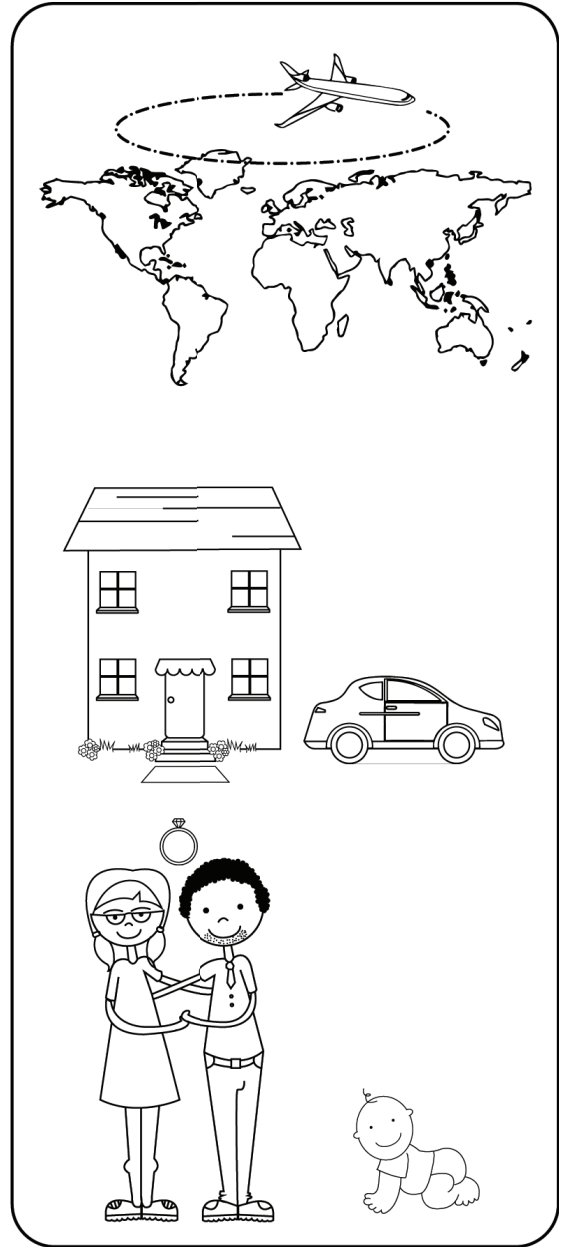

future



busy

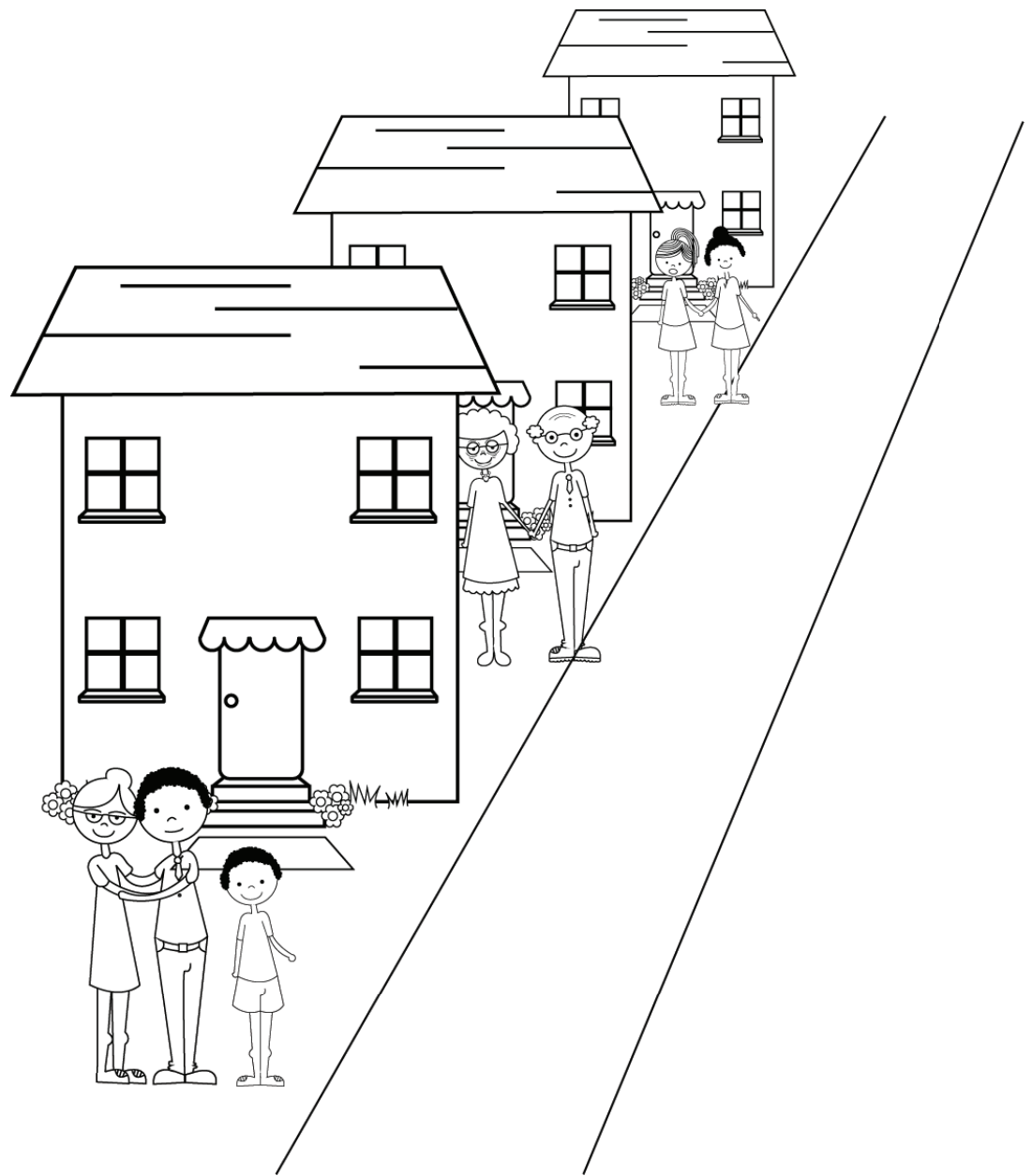

neighbourhood

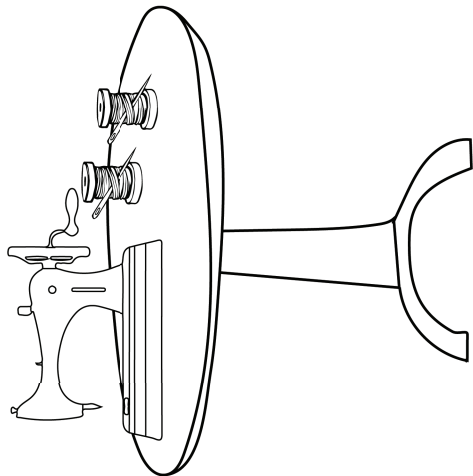
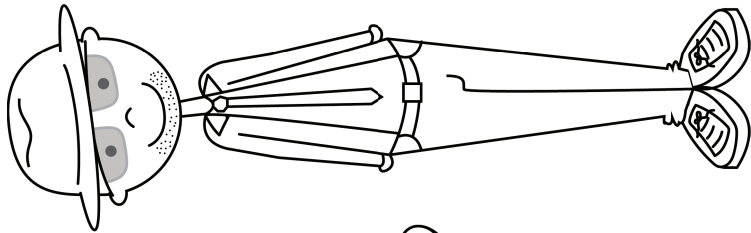
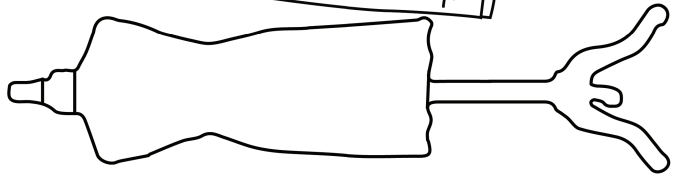
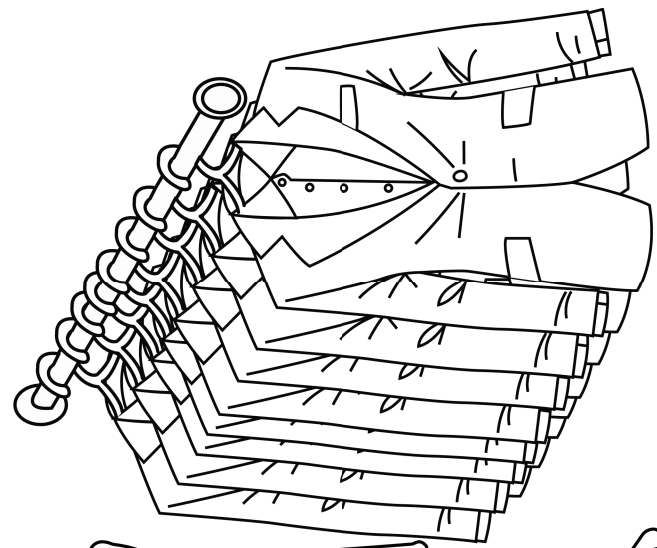

tailor

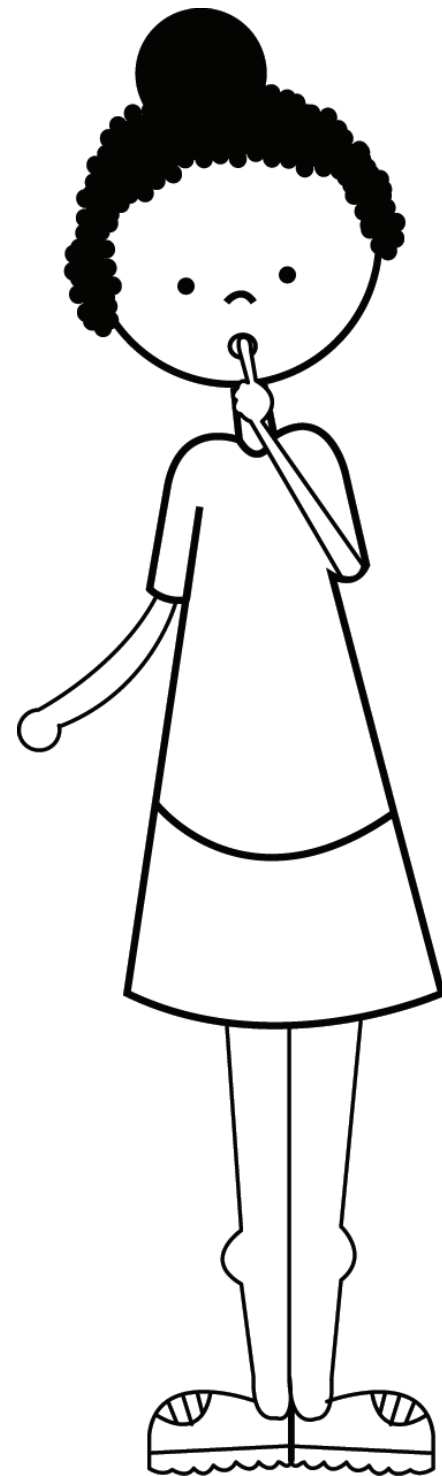

quiet

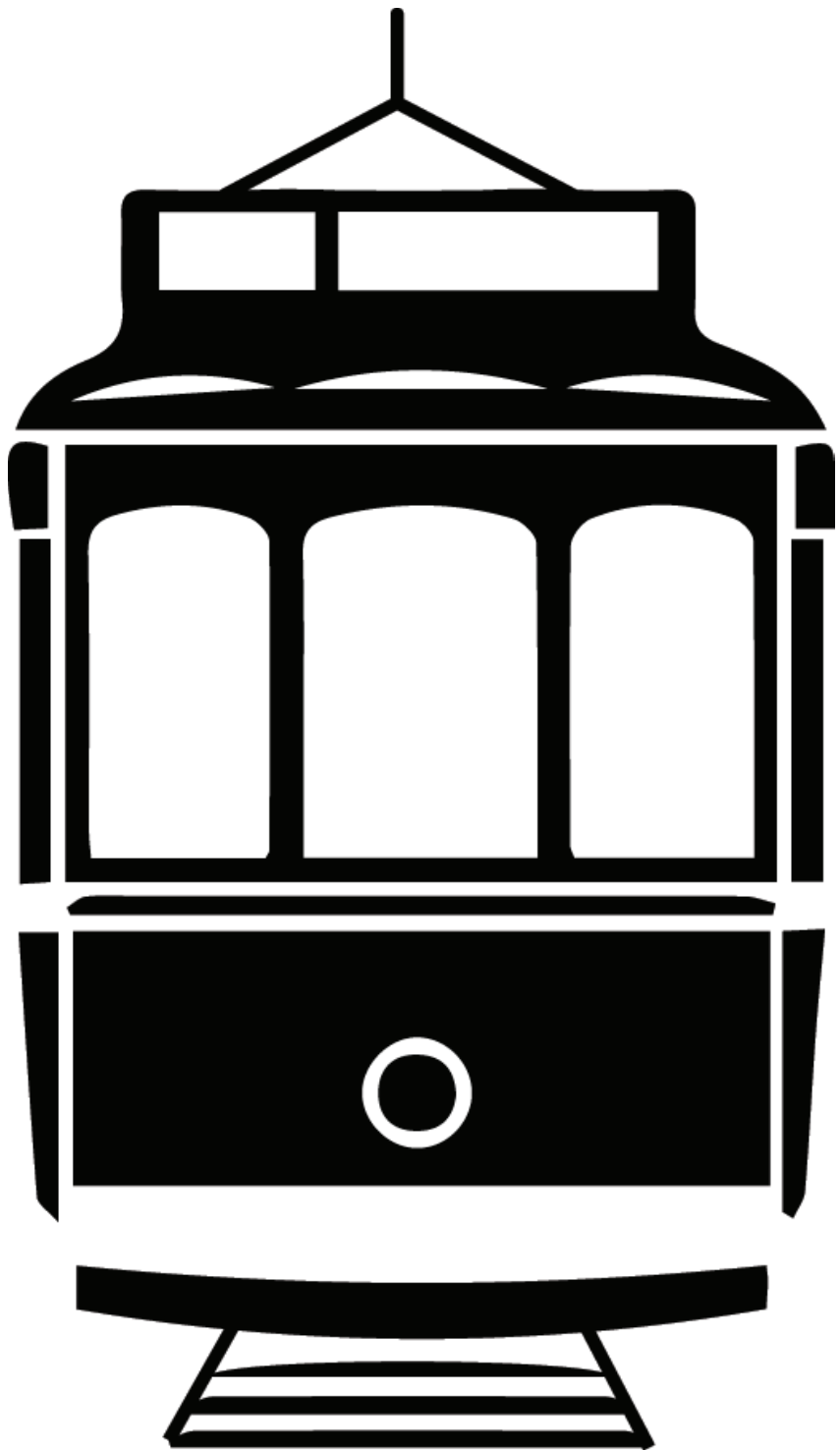

tram



barbershop

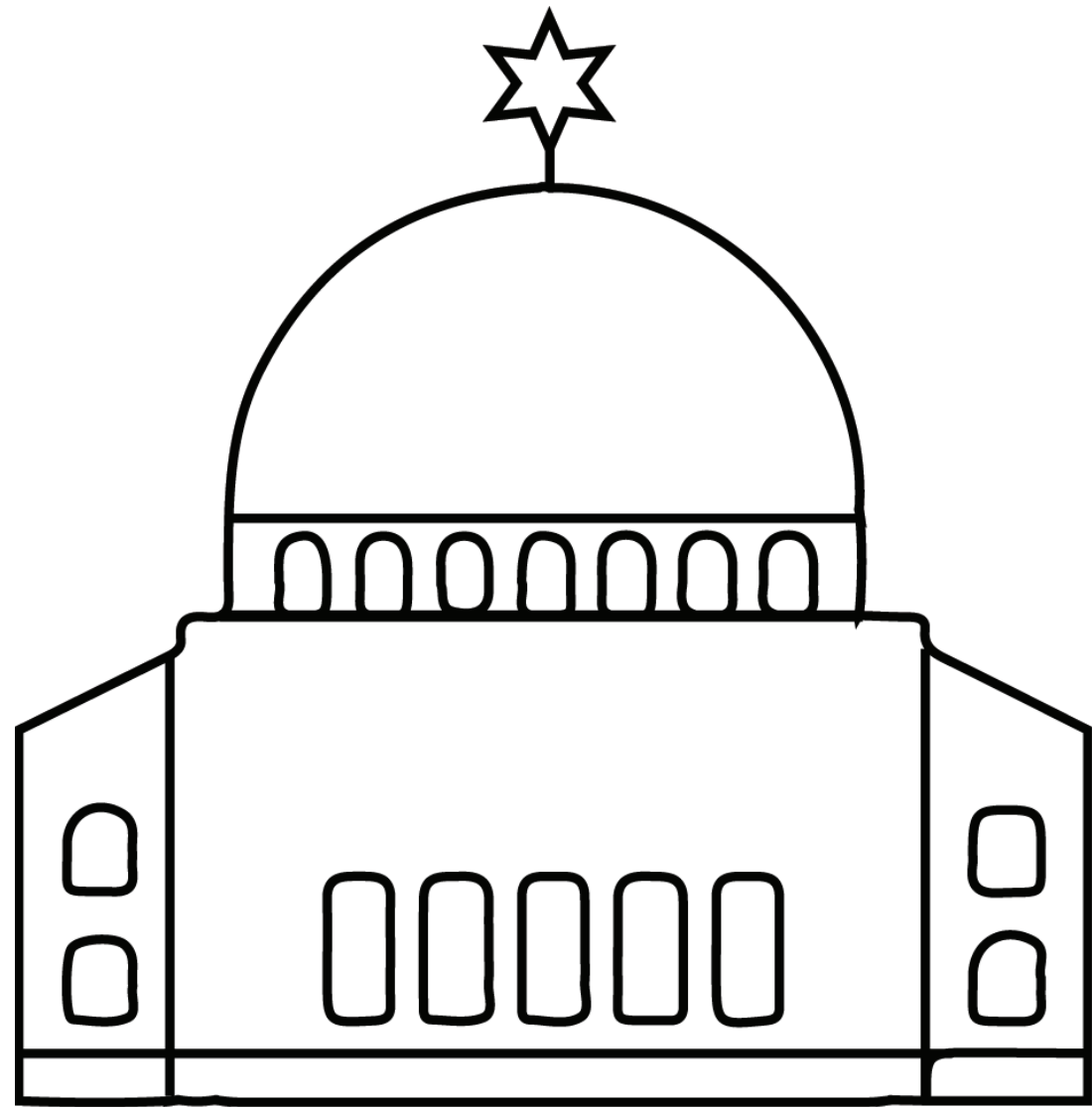

synagogue

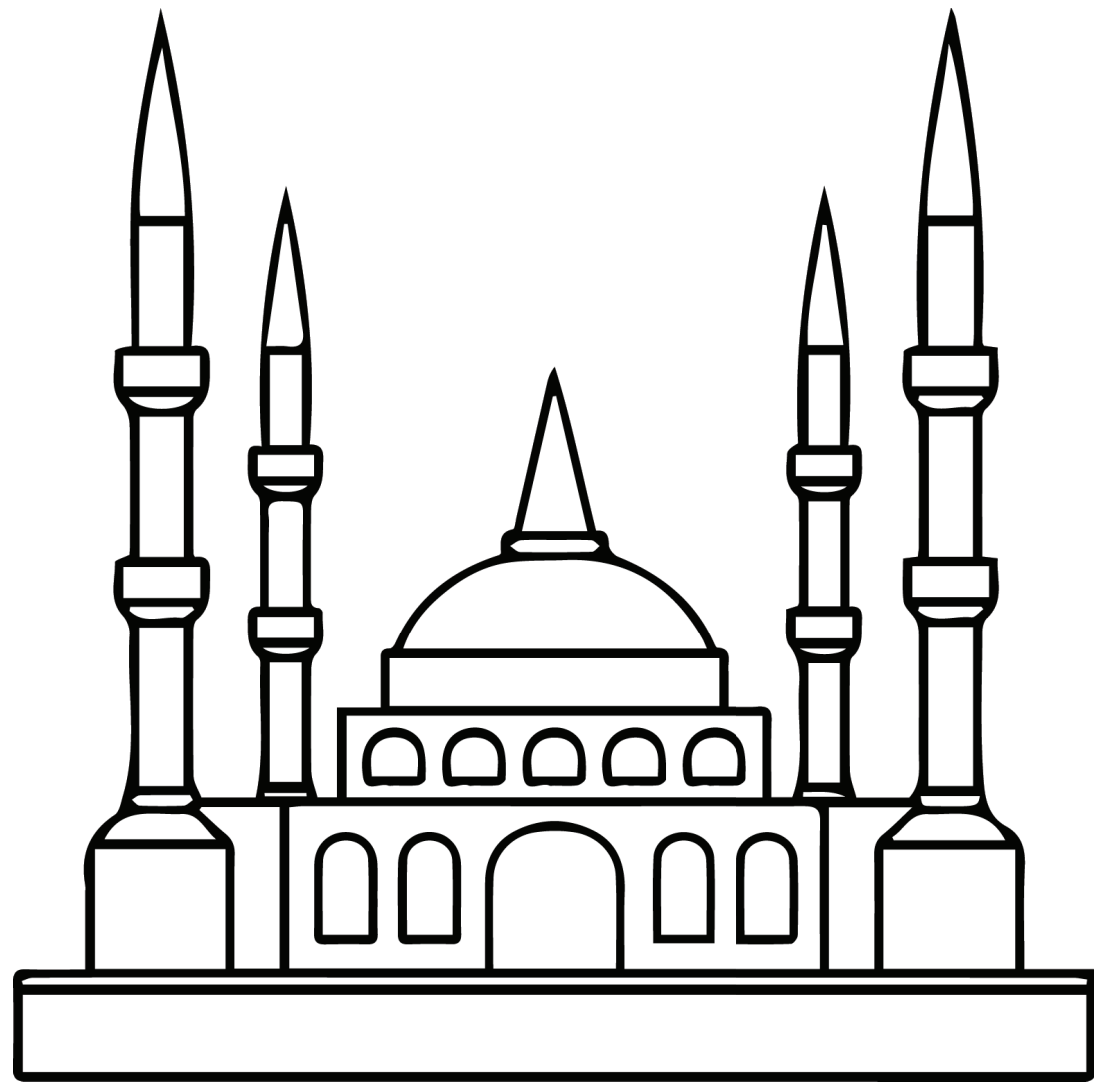

mosque

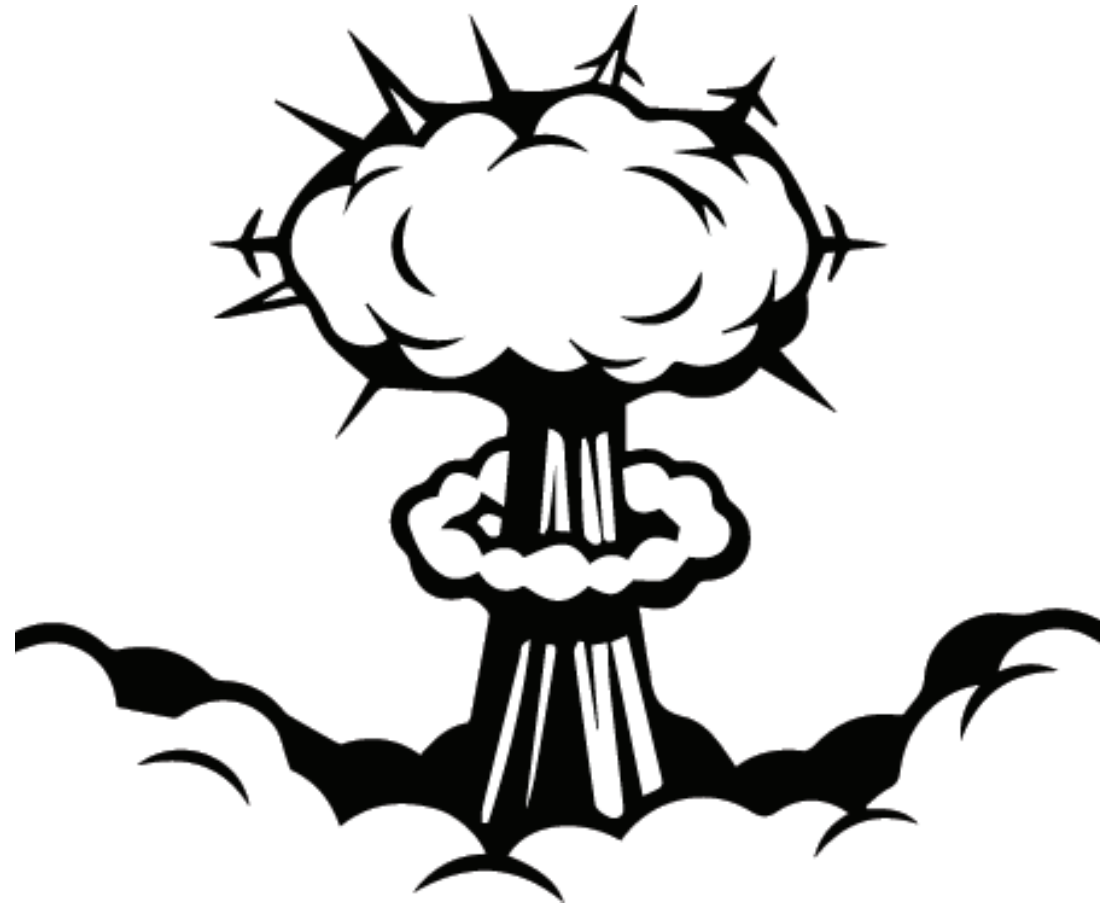

destroy

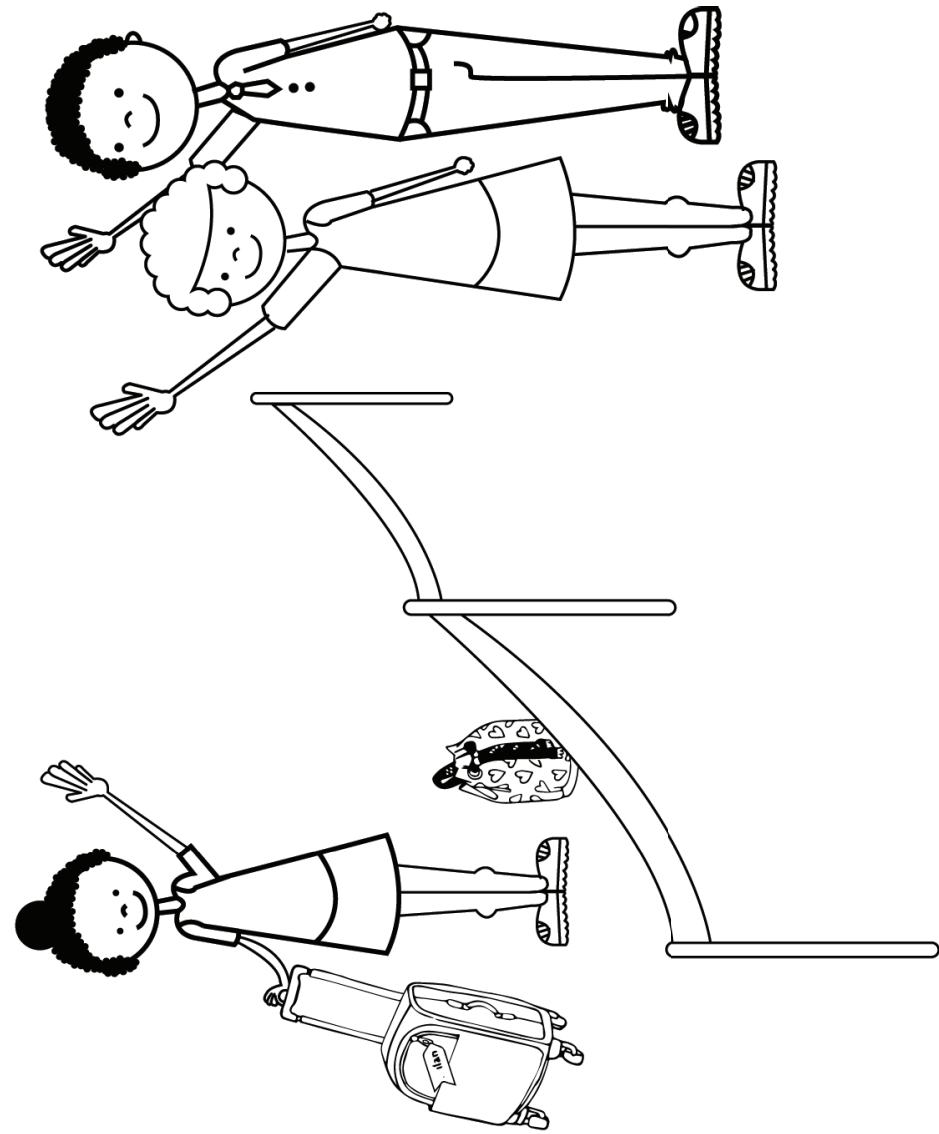

leave

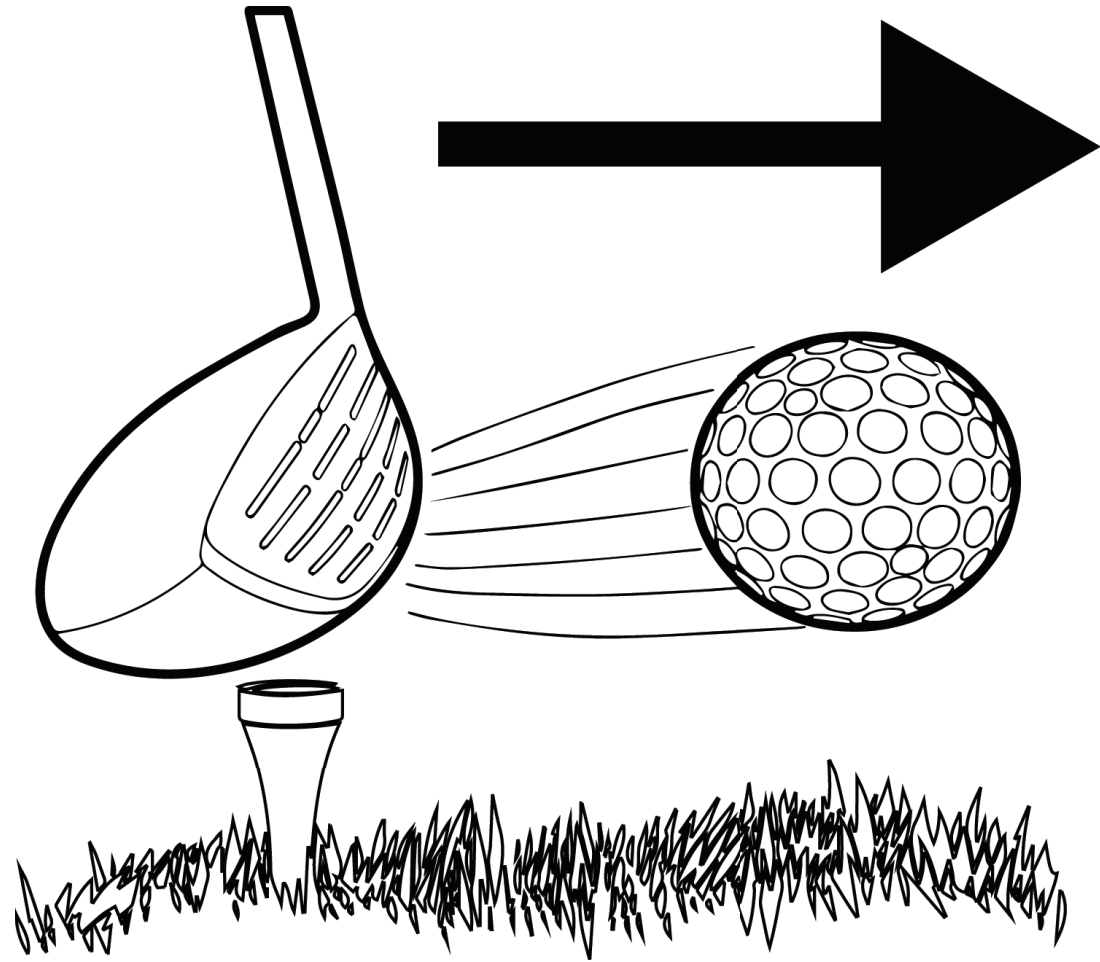

force

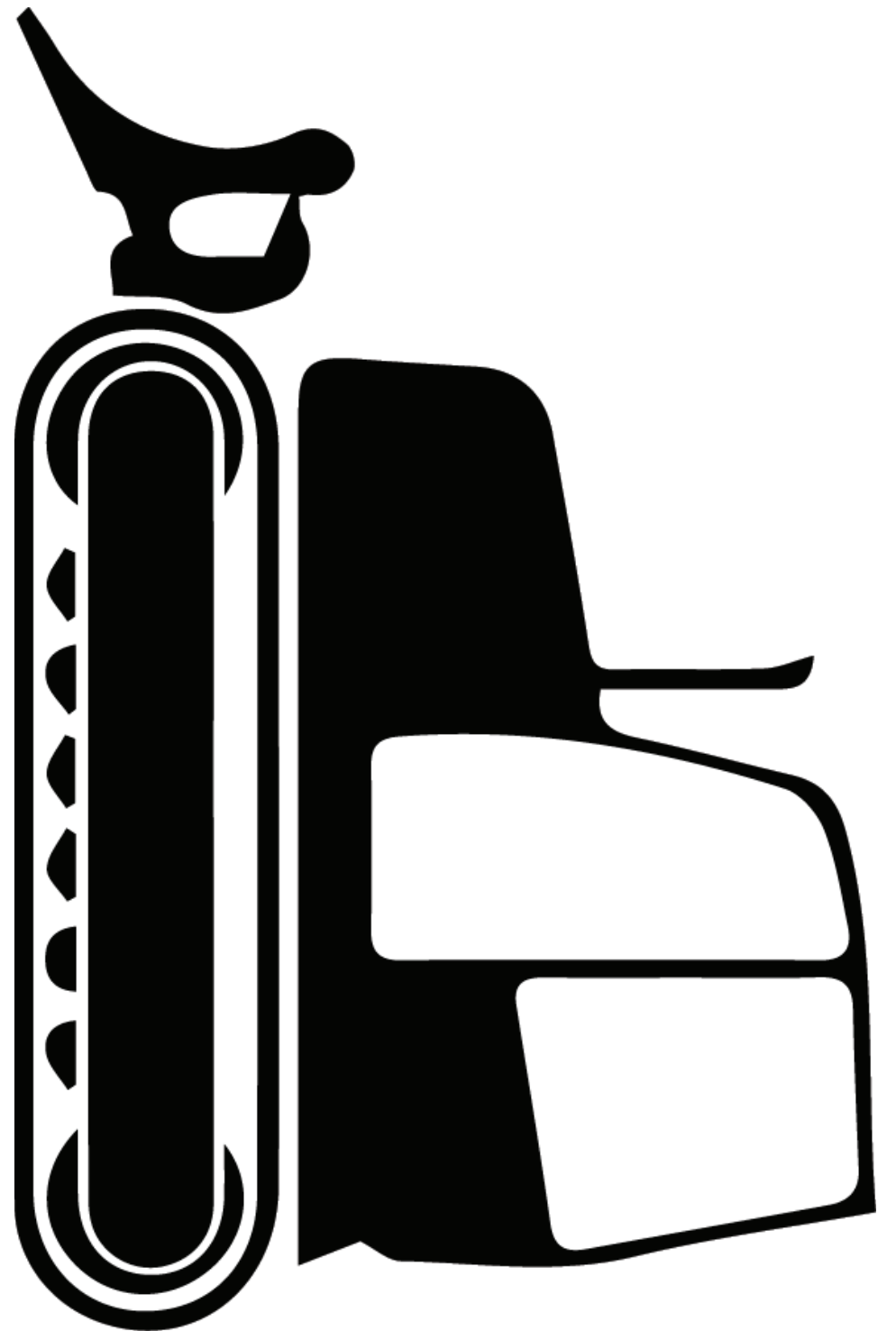

bulldozer



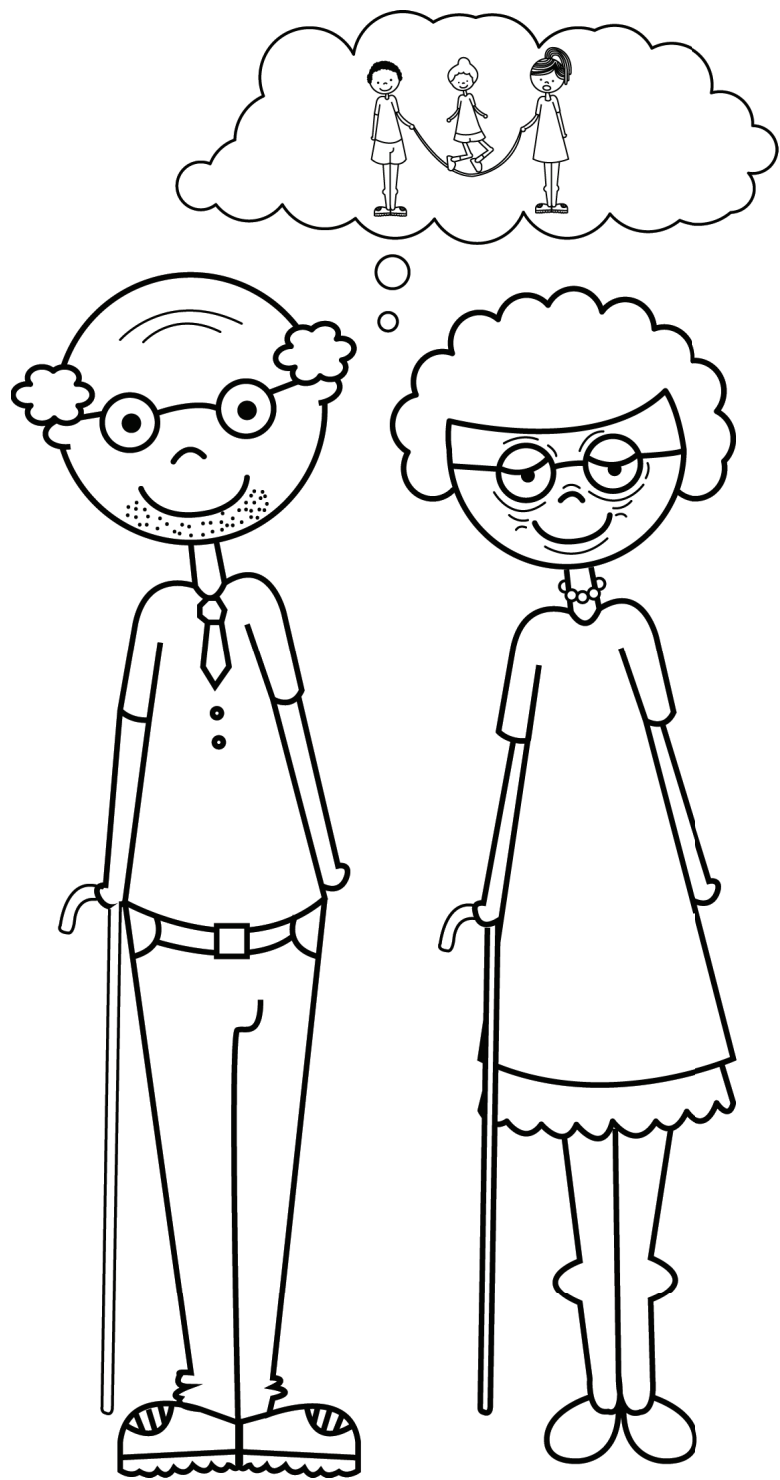

remember

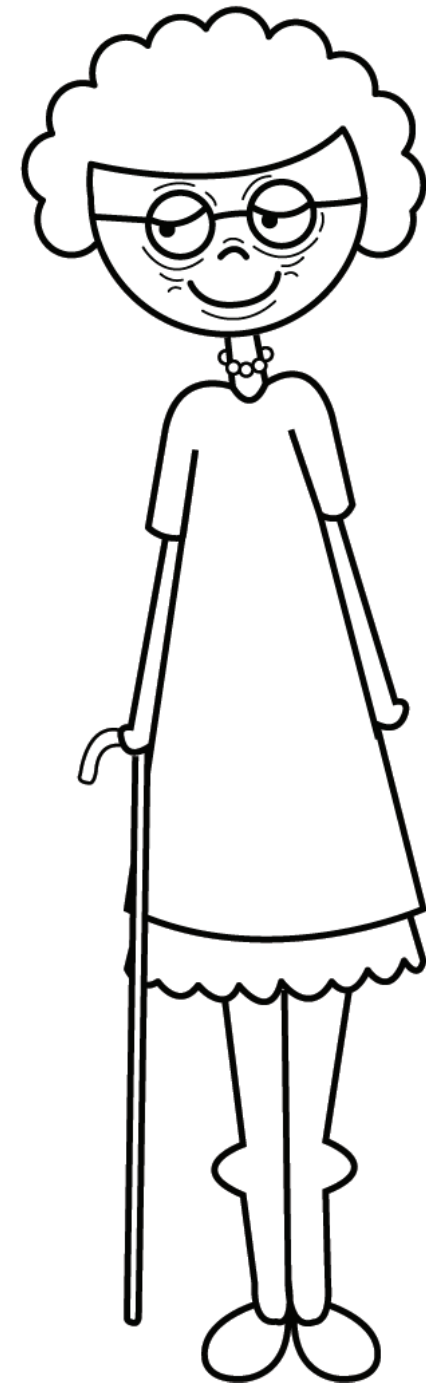
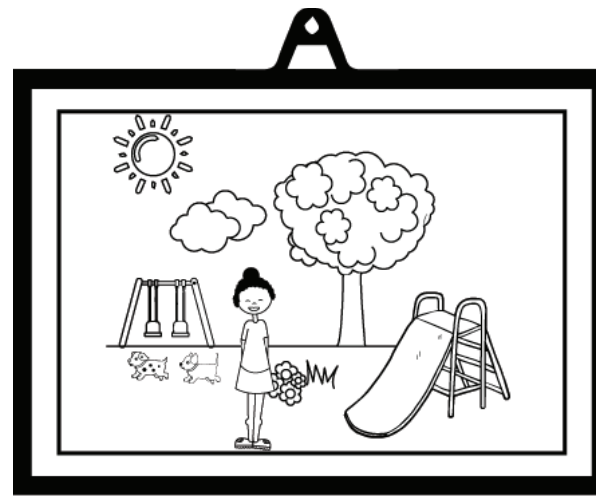

memory

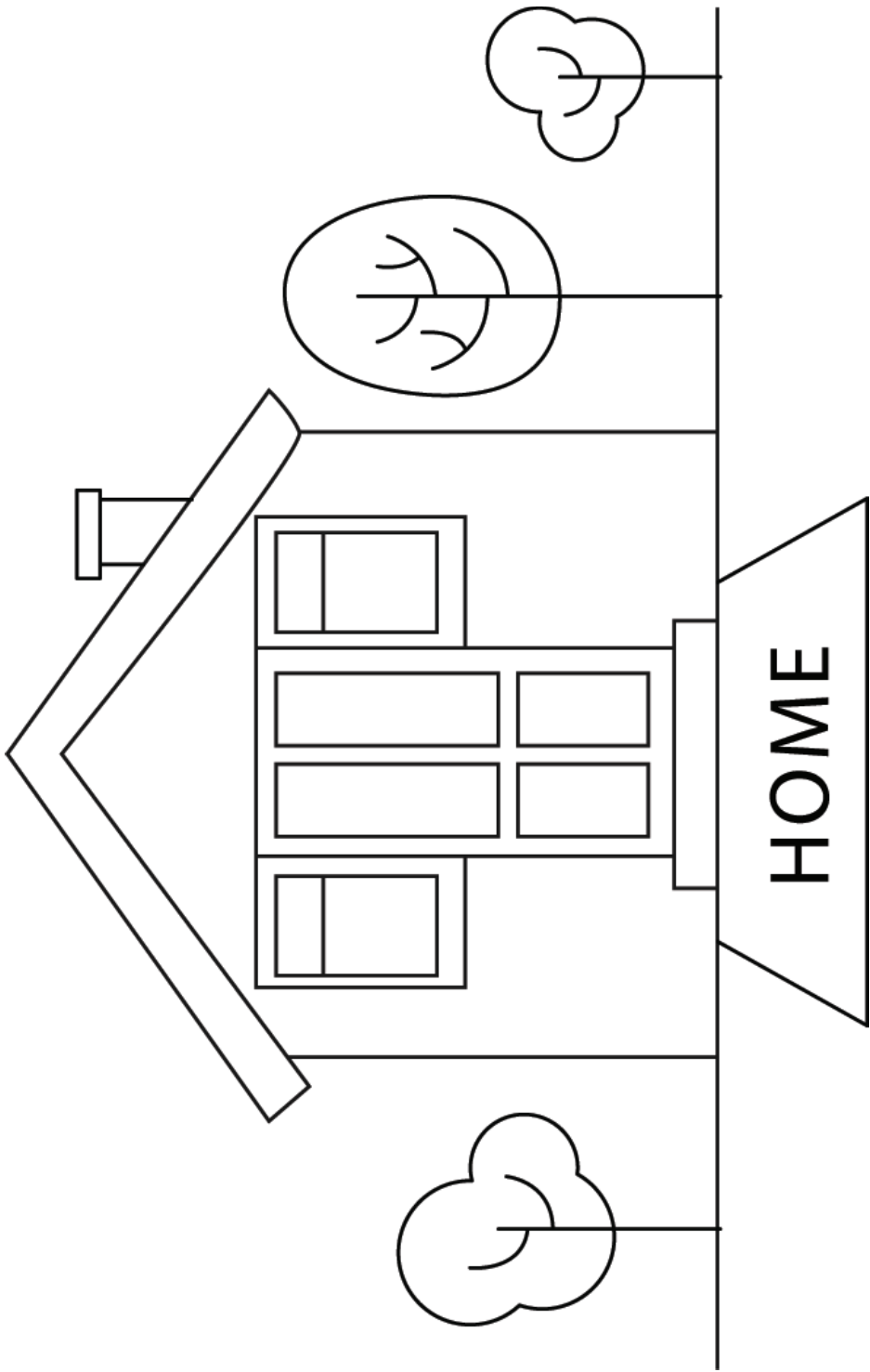

home

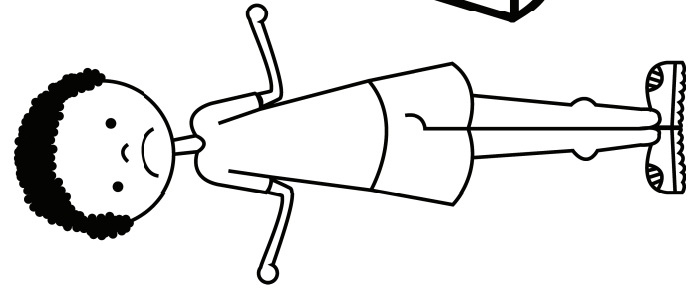
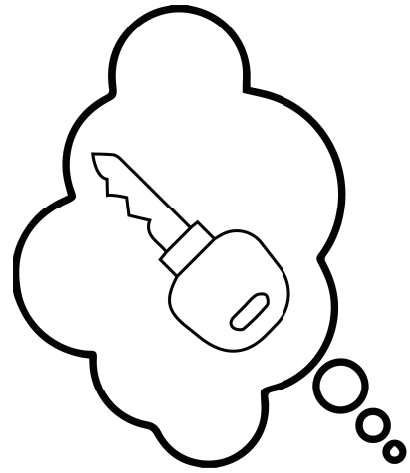

forget

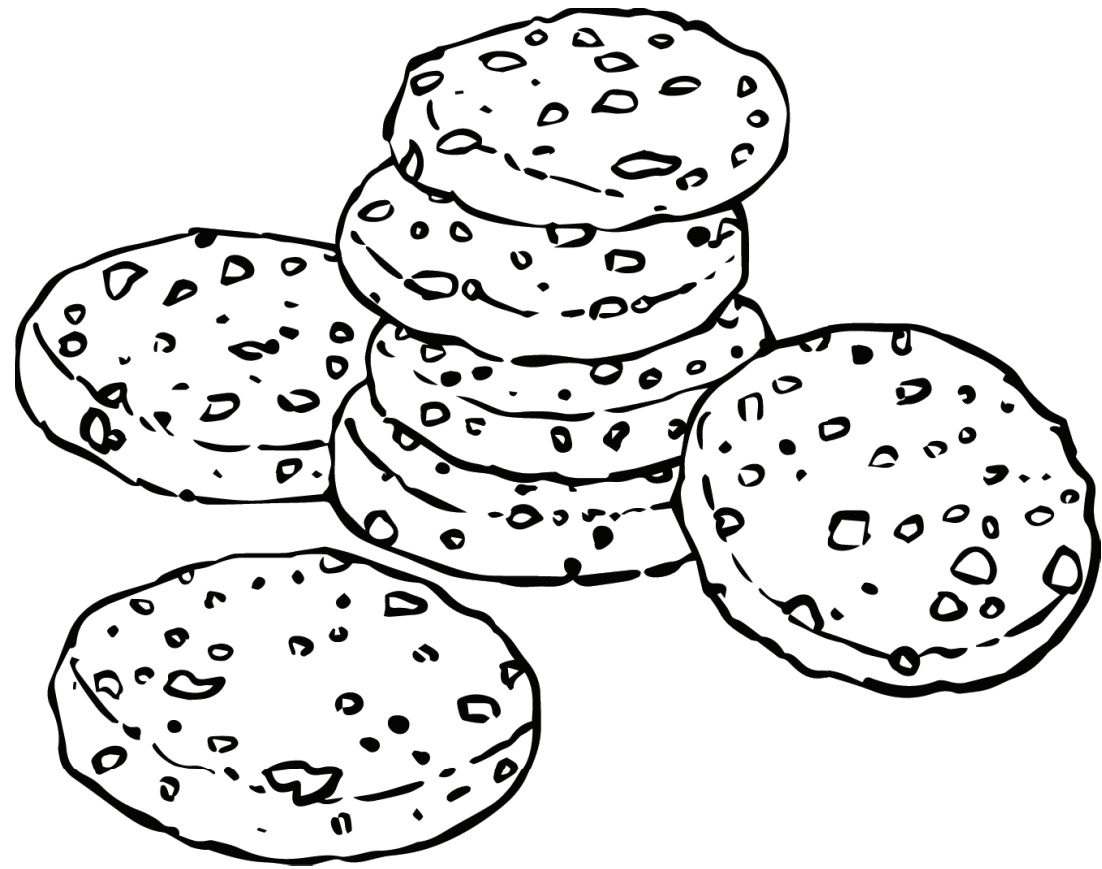

biscuits / koekies

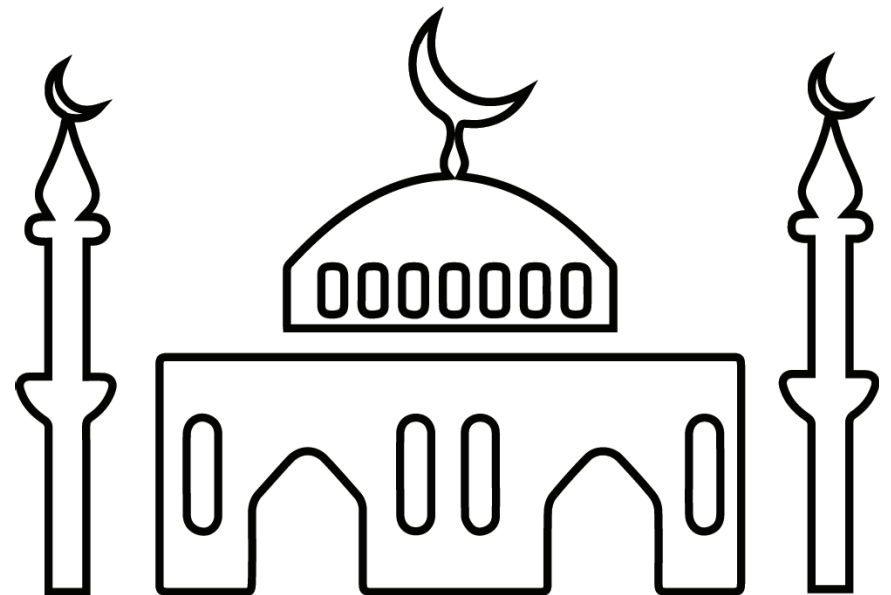
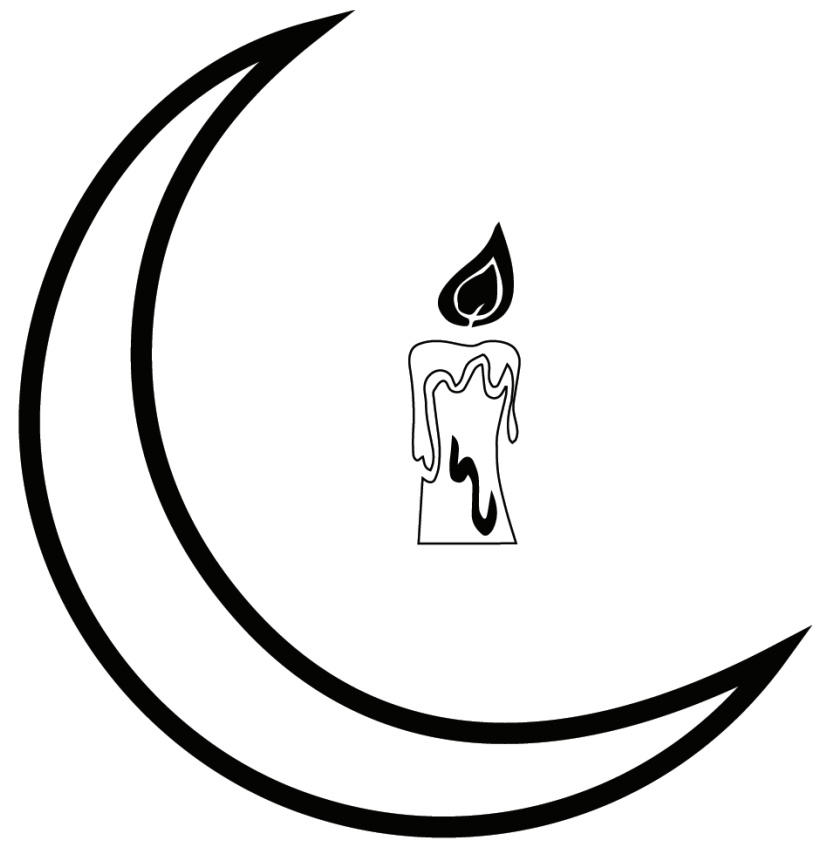

Ramadan



fast



tradition

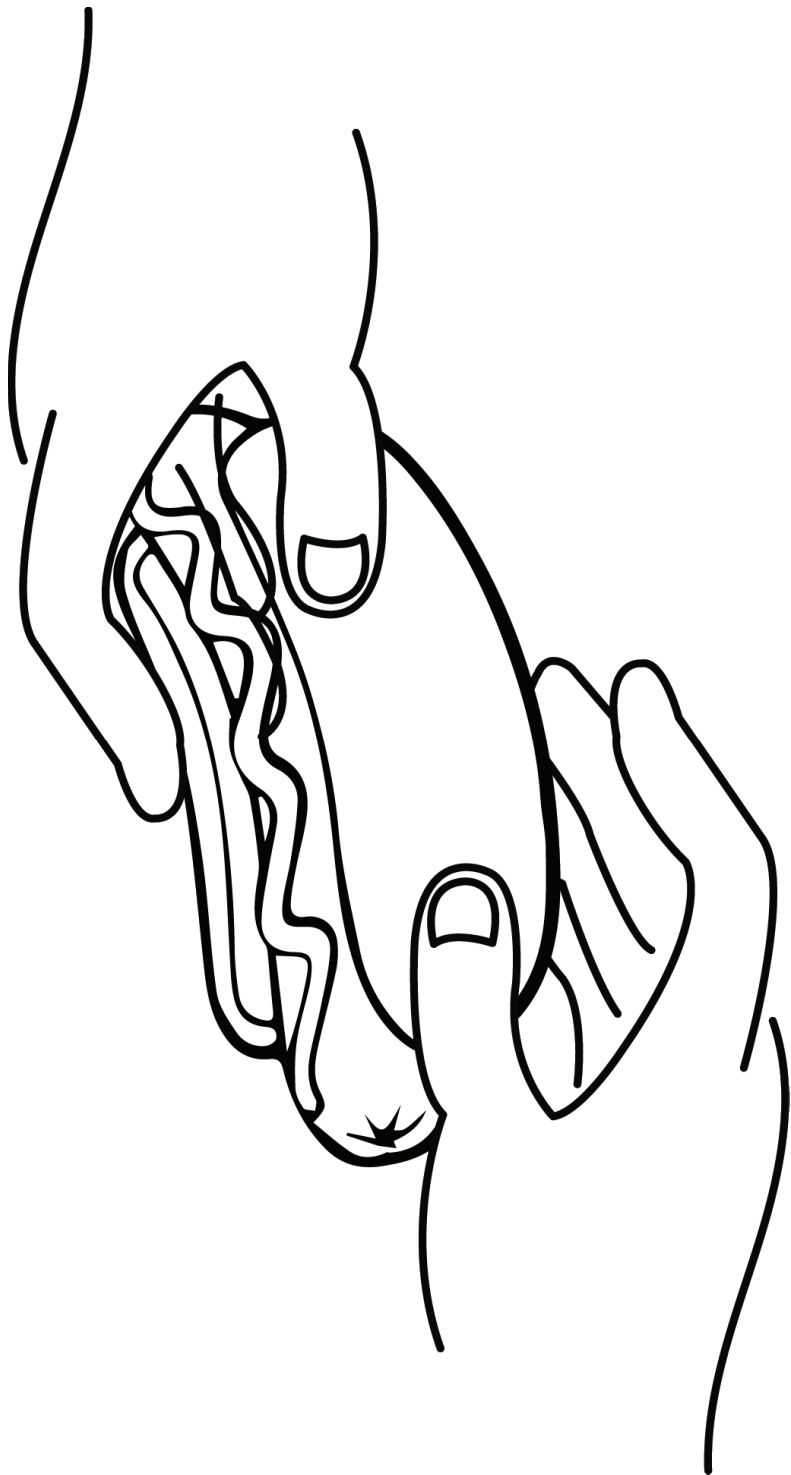

share



hungry

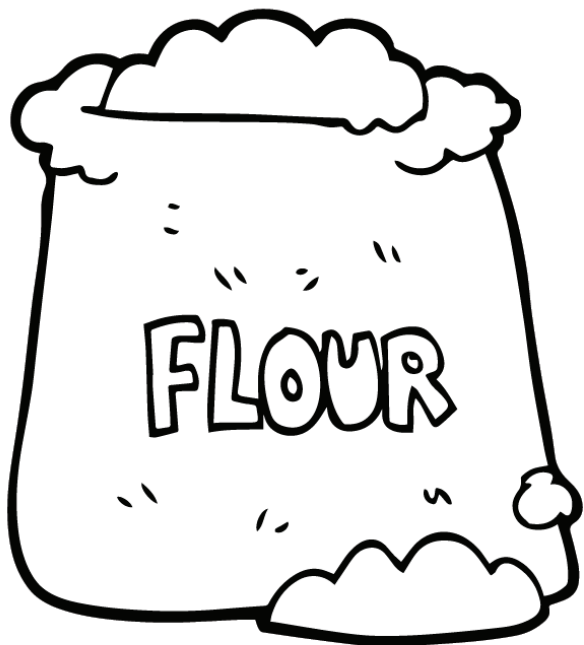
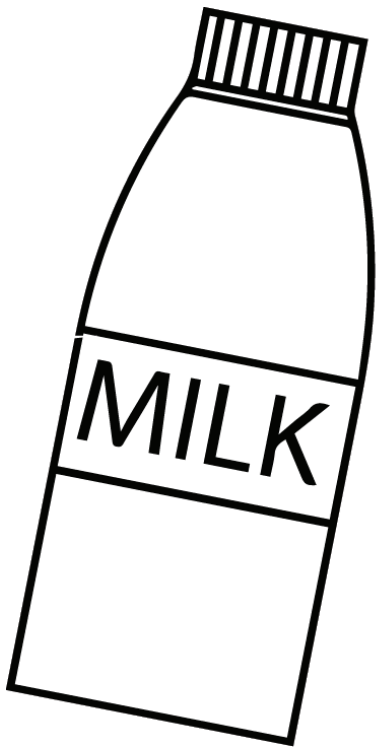

ingredients



measure

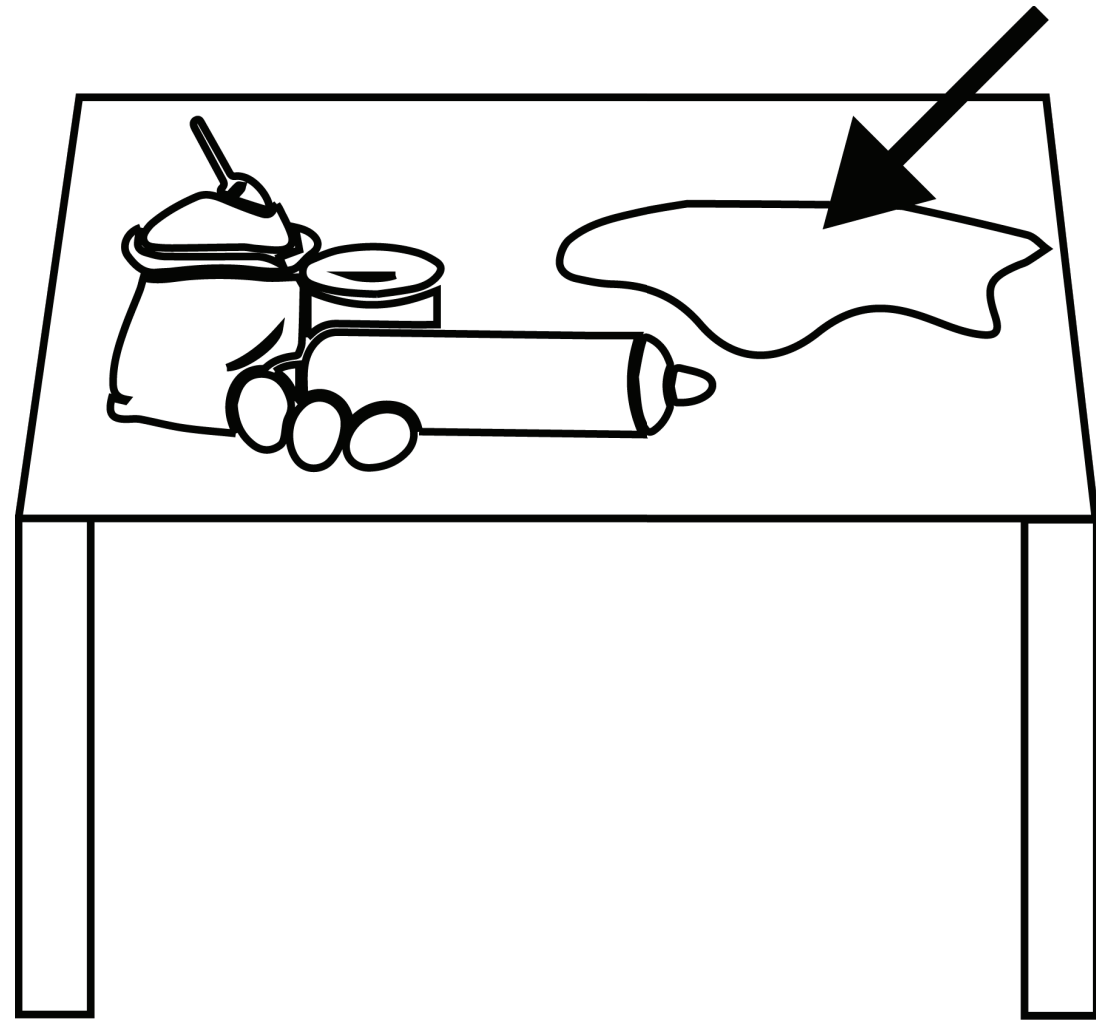

dough



knead

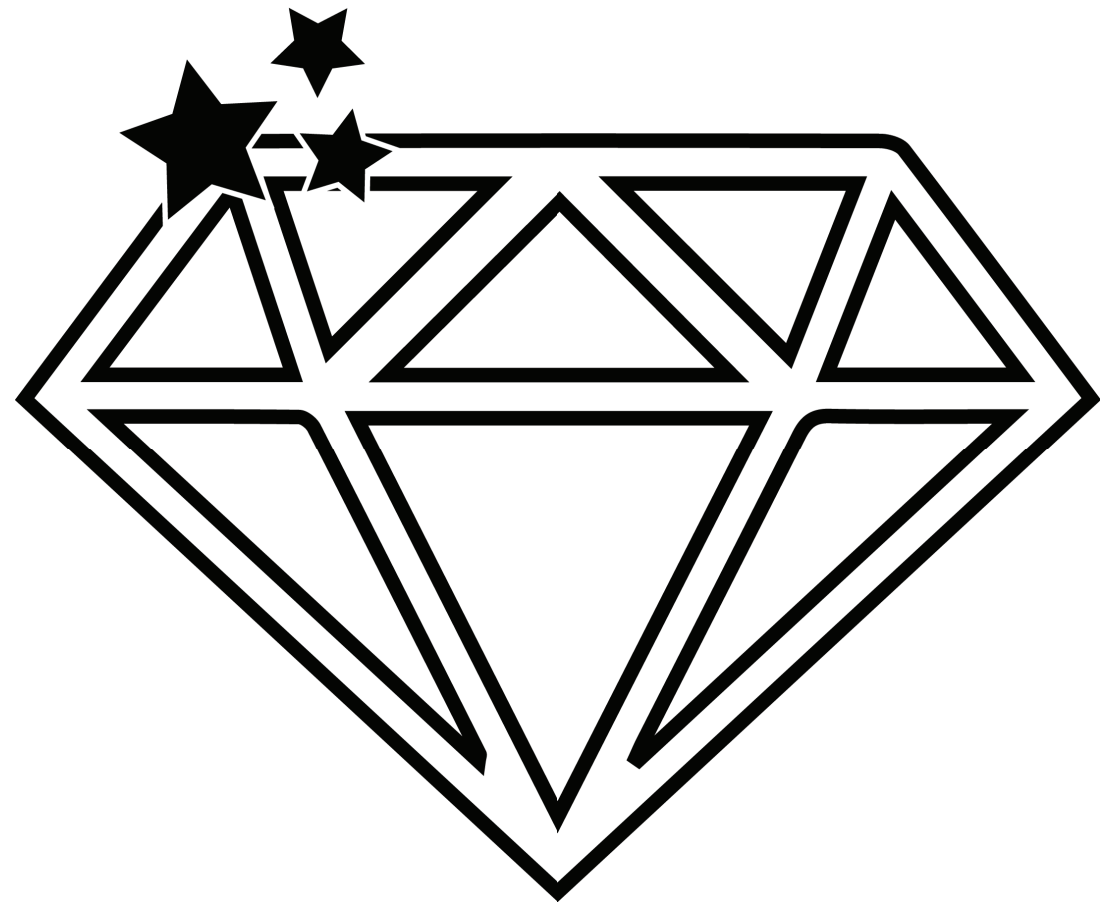

sparkle / sparkly

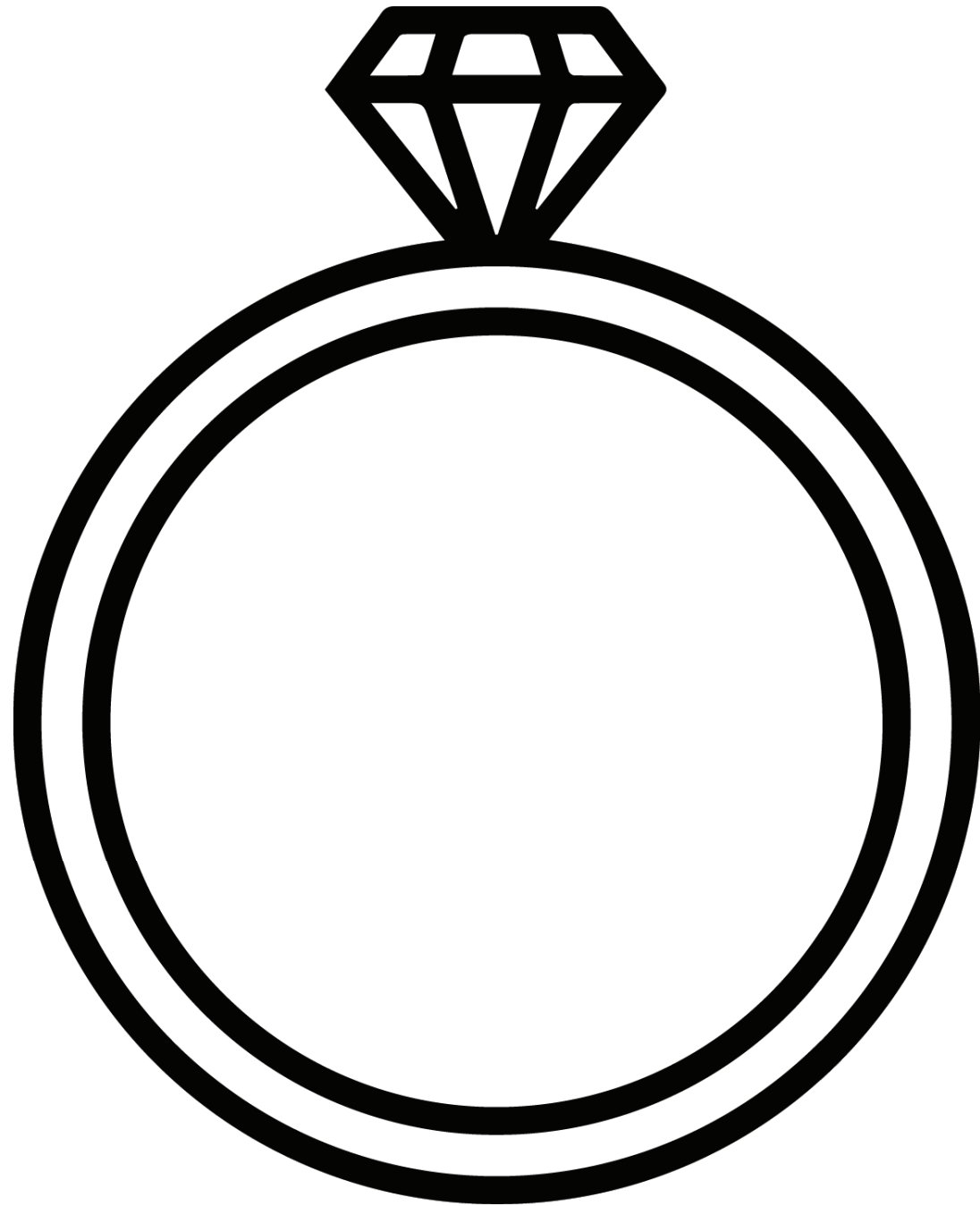

ring





gasp

# FINAL EXAM

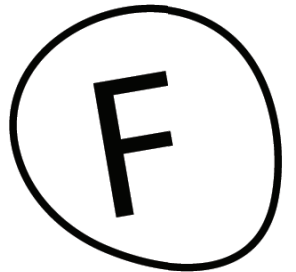
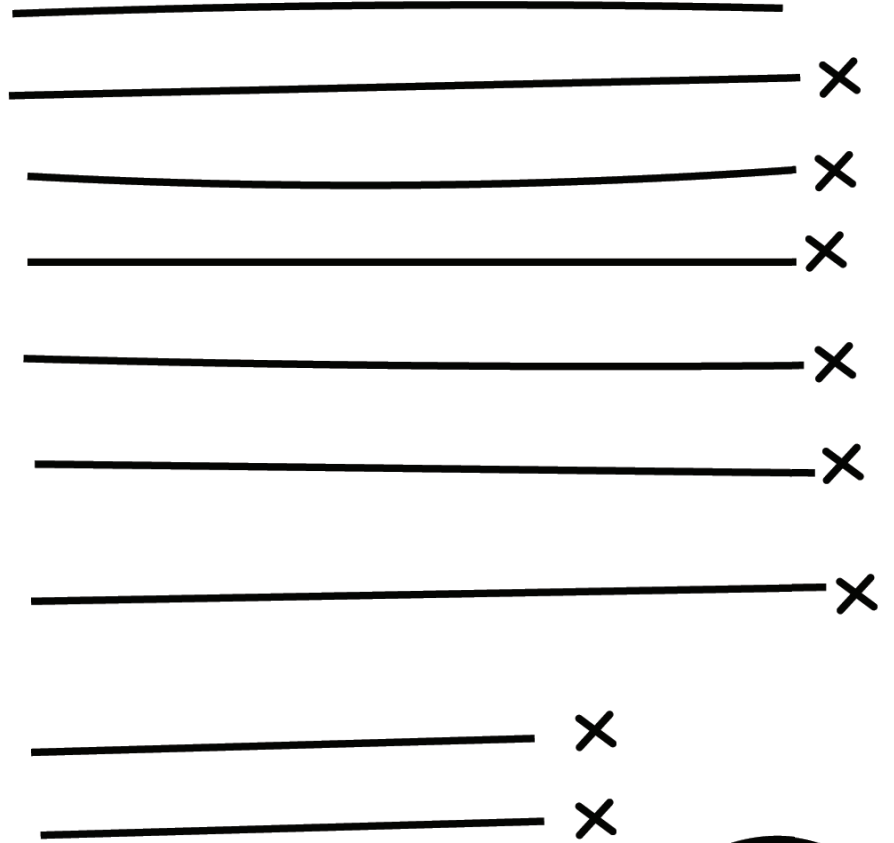

terrible

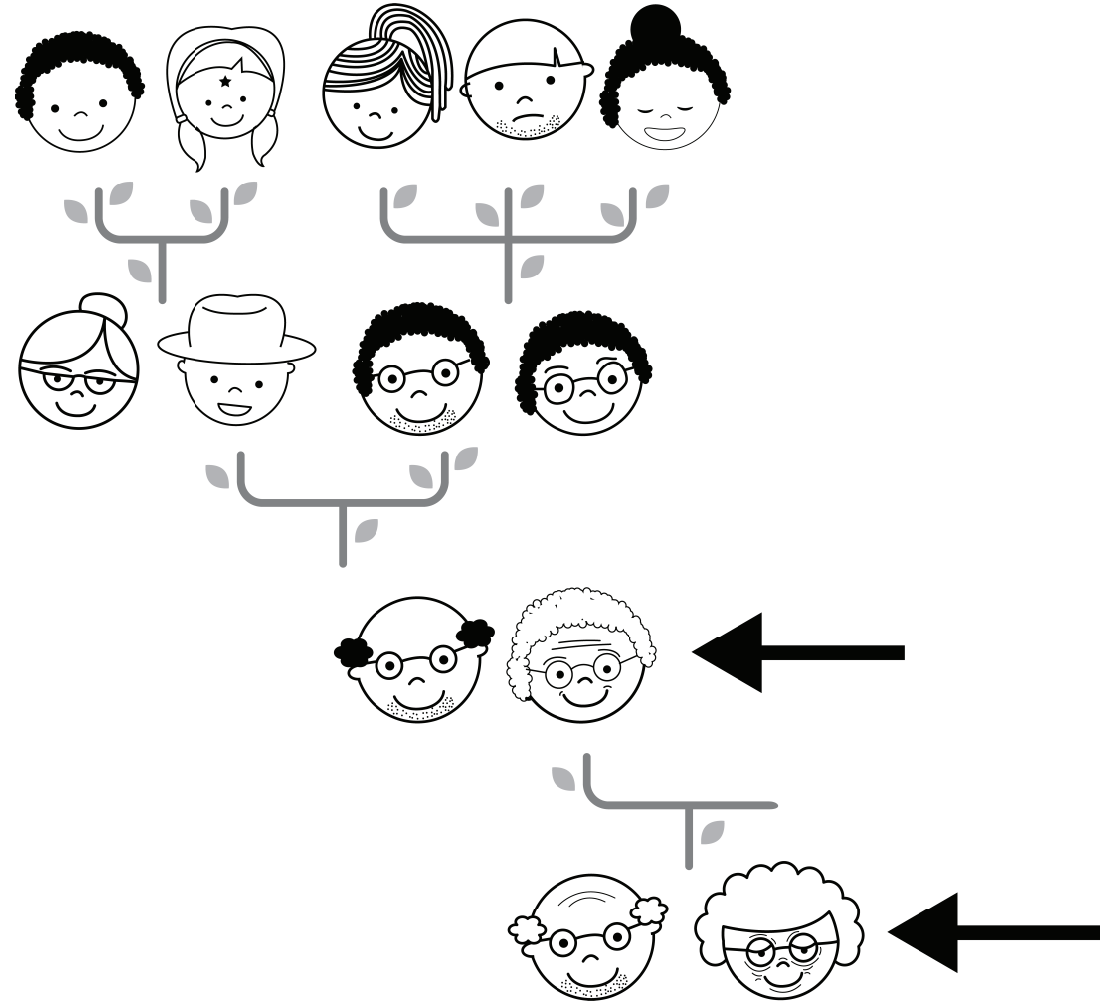

grandmother / great-grandmother

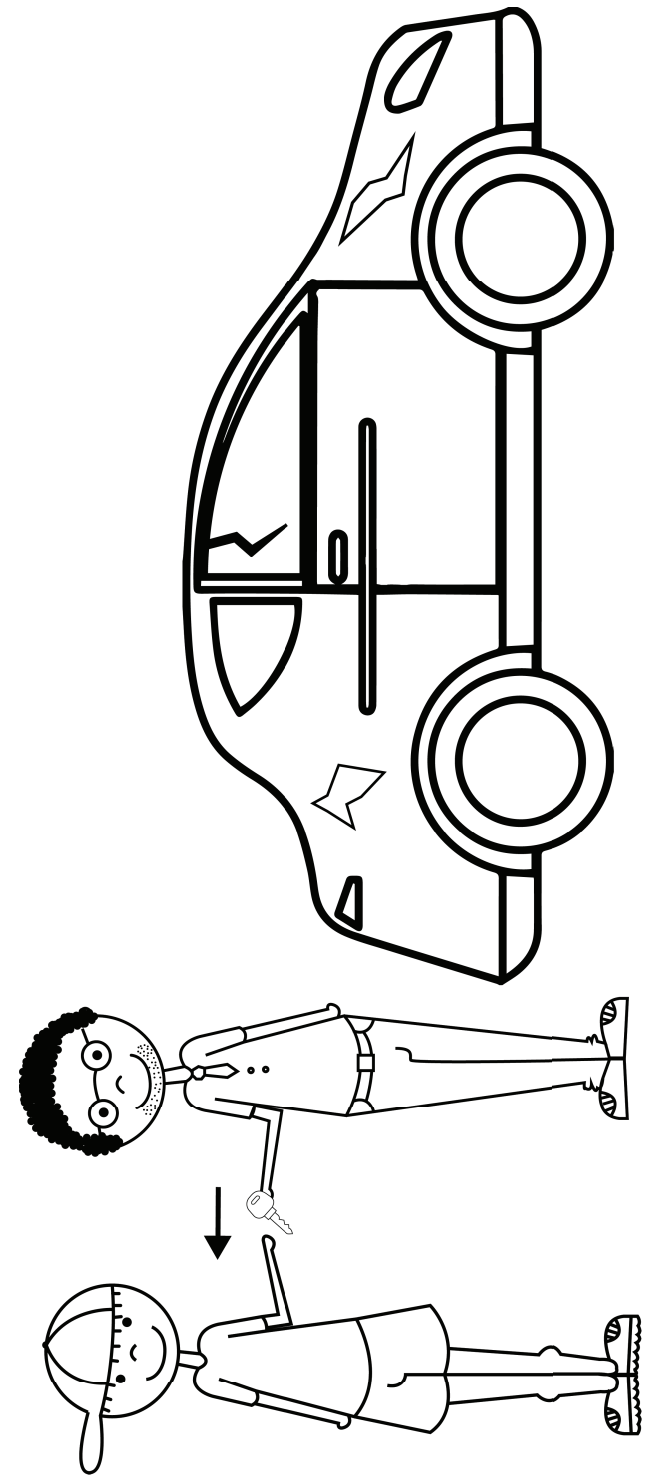

pass down

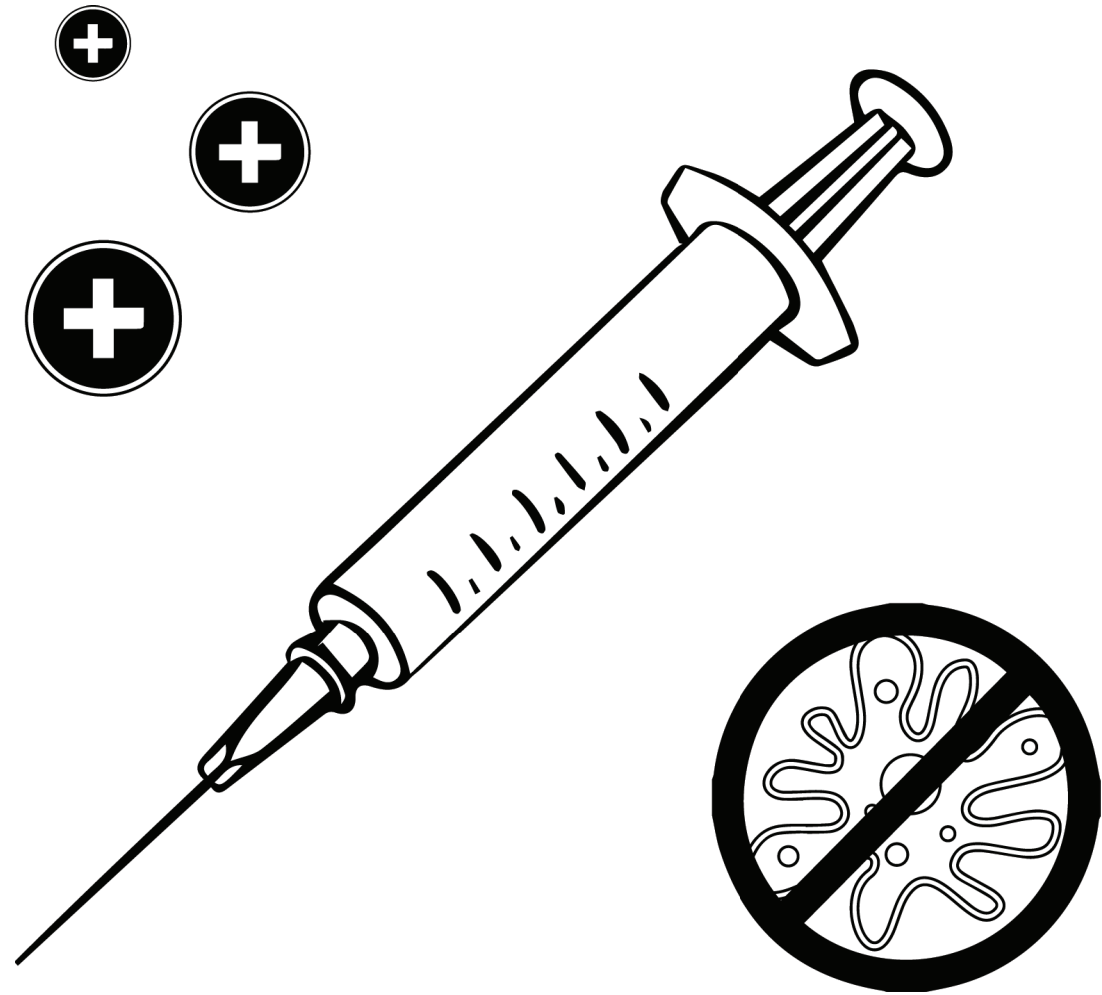

vaccine

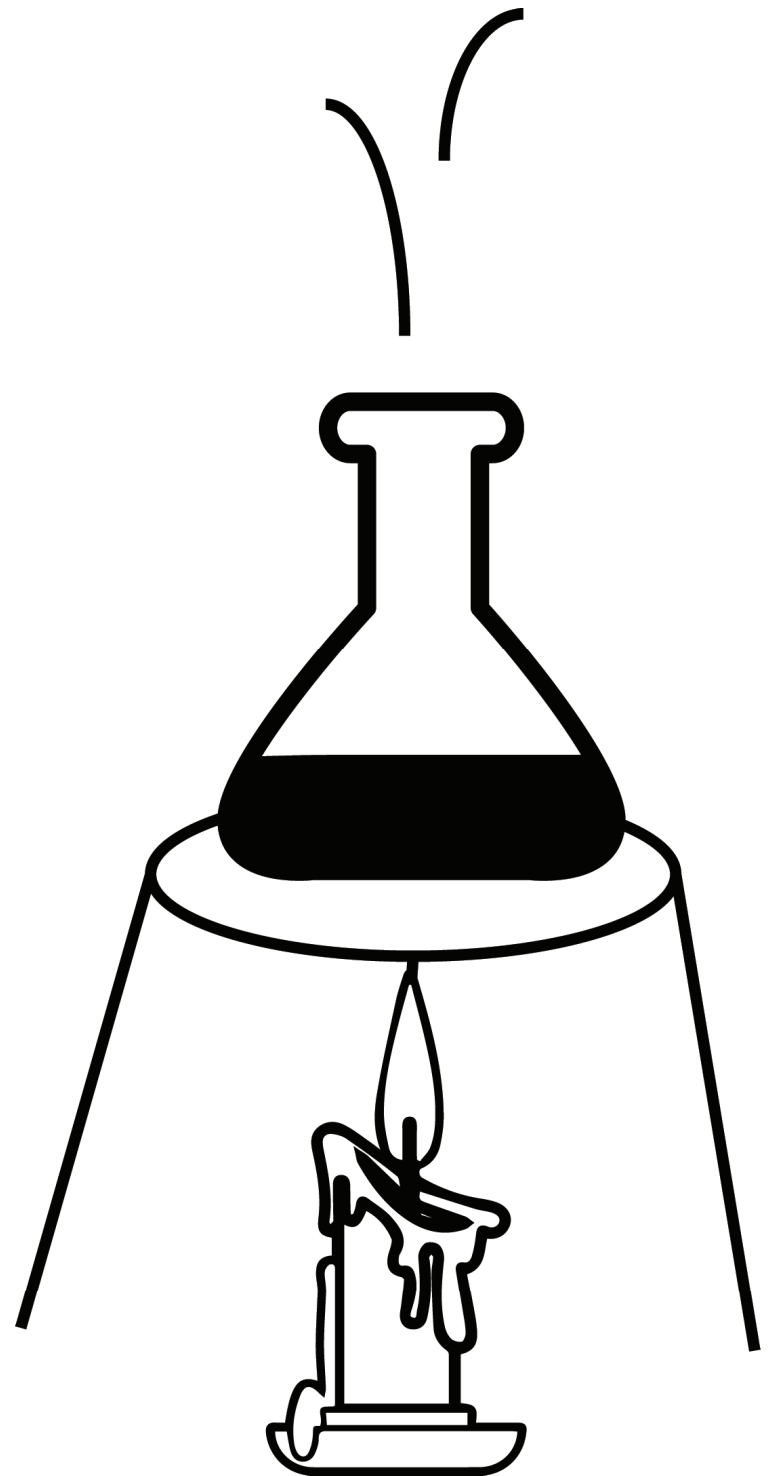

experiment

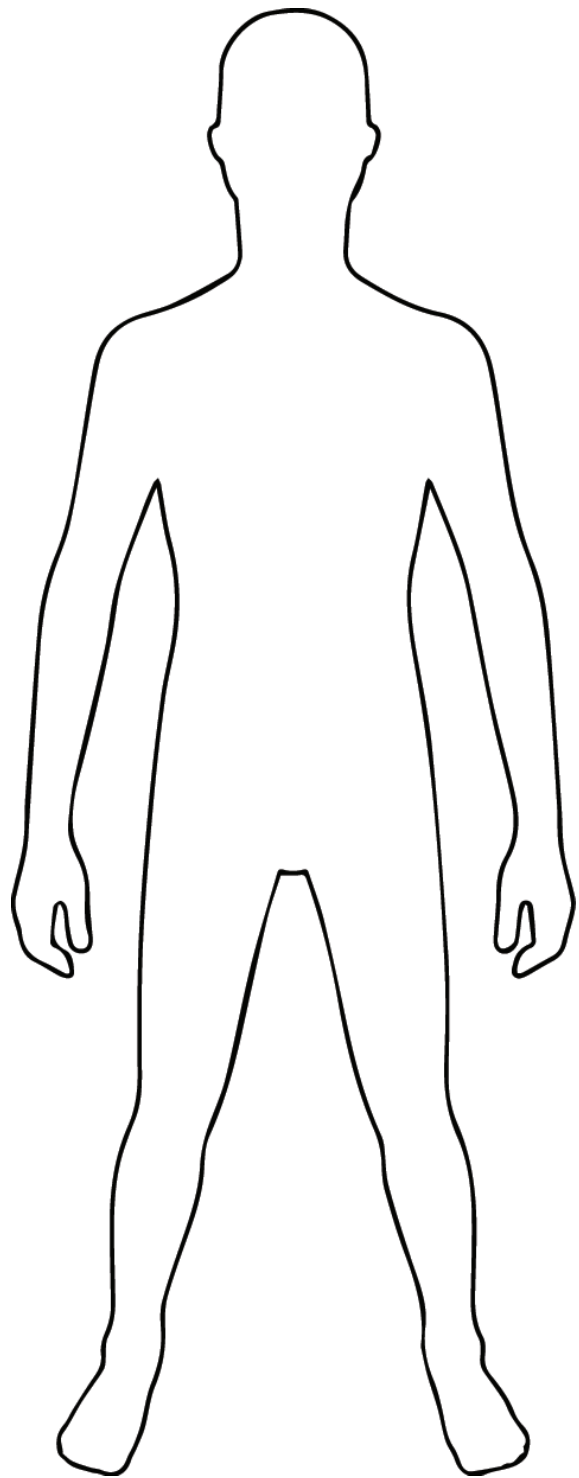

body

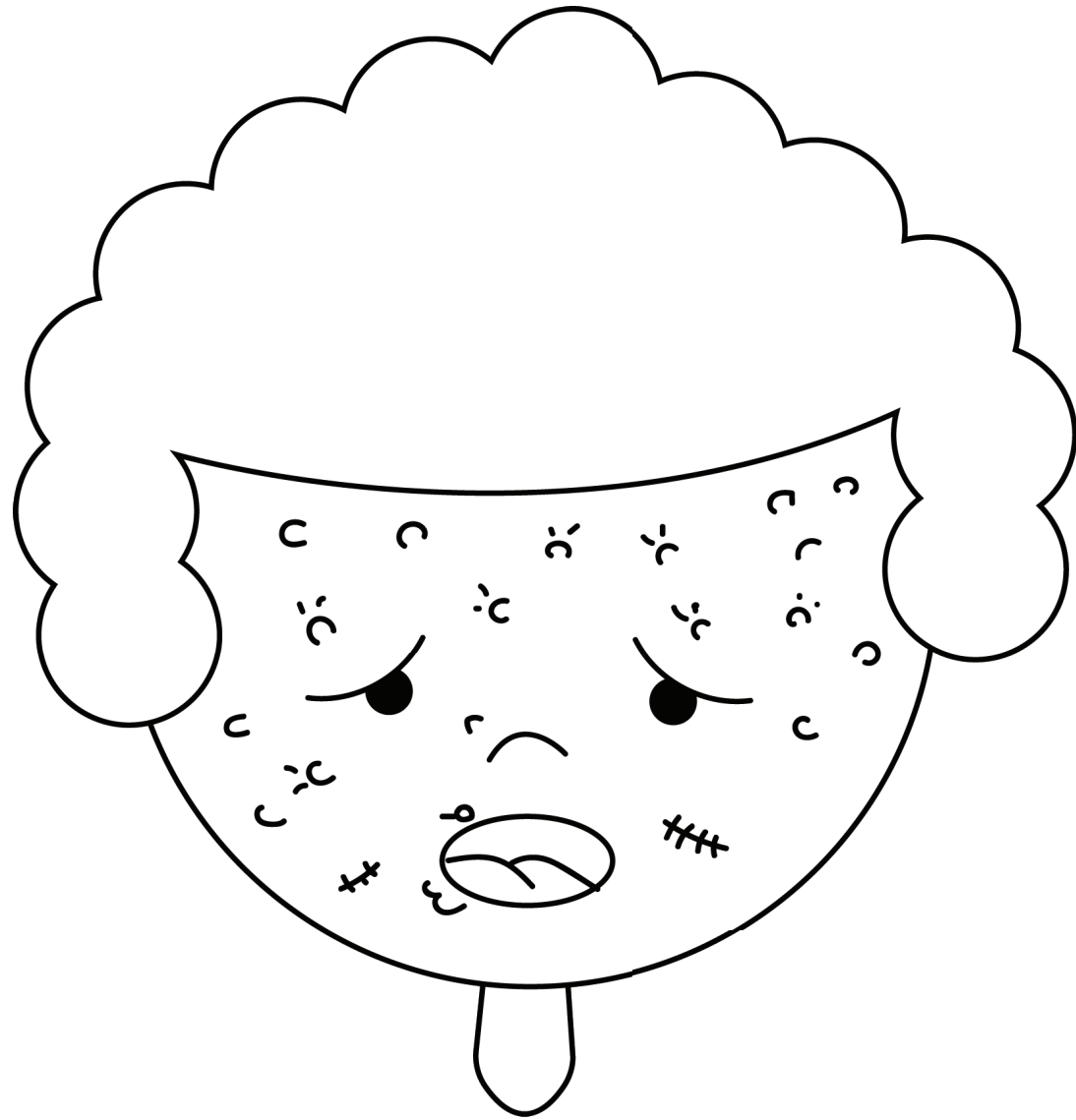

disease

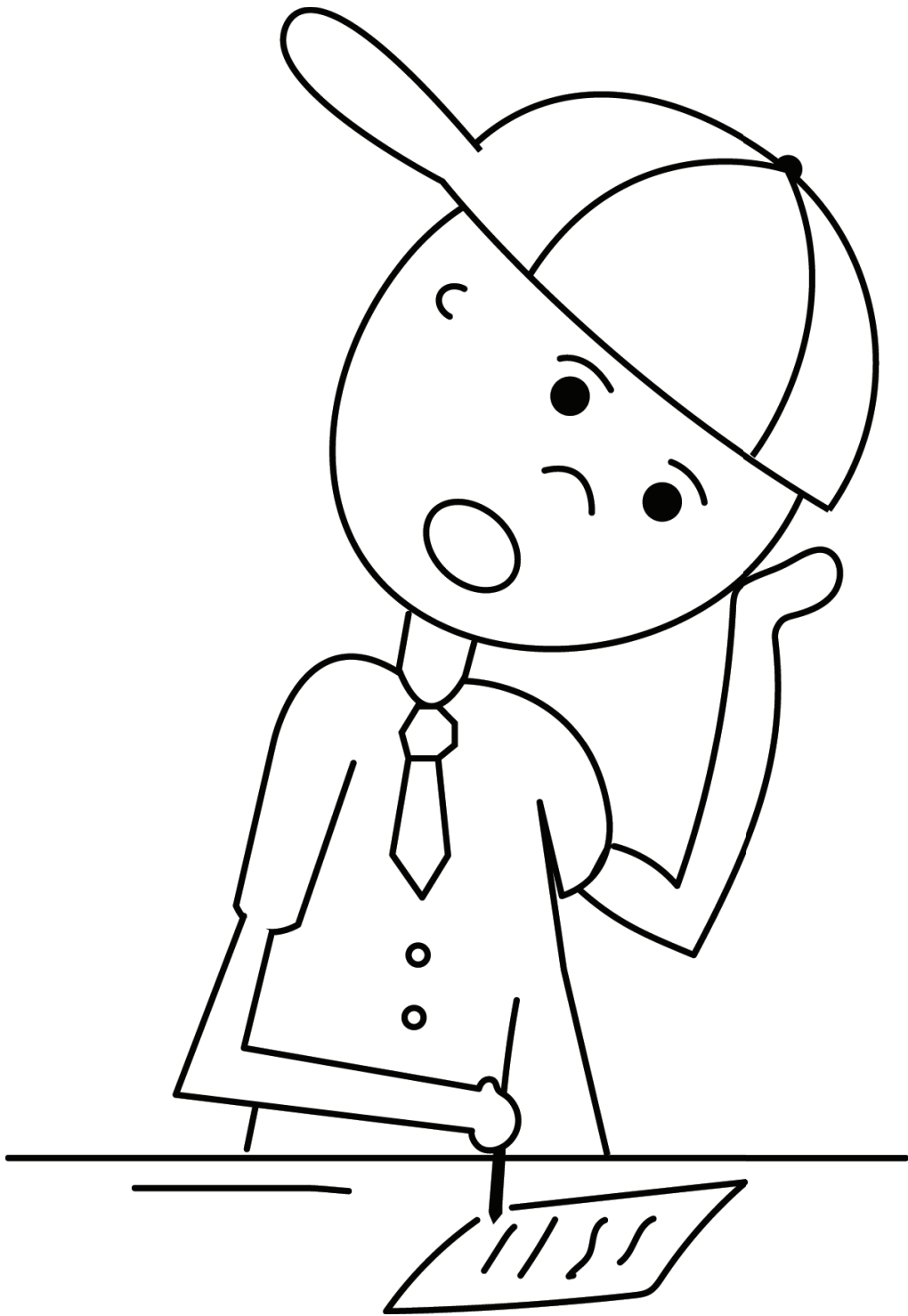

test

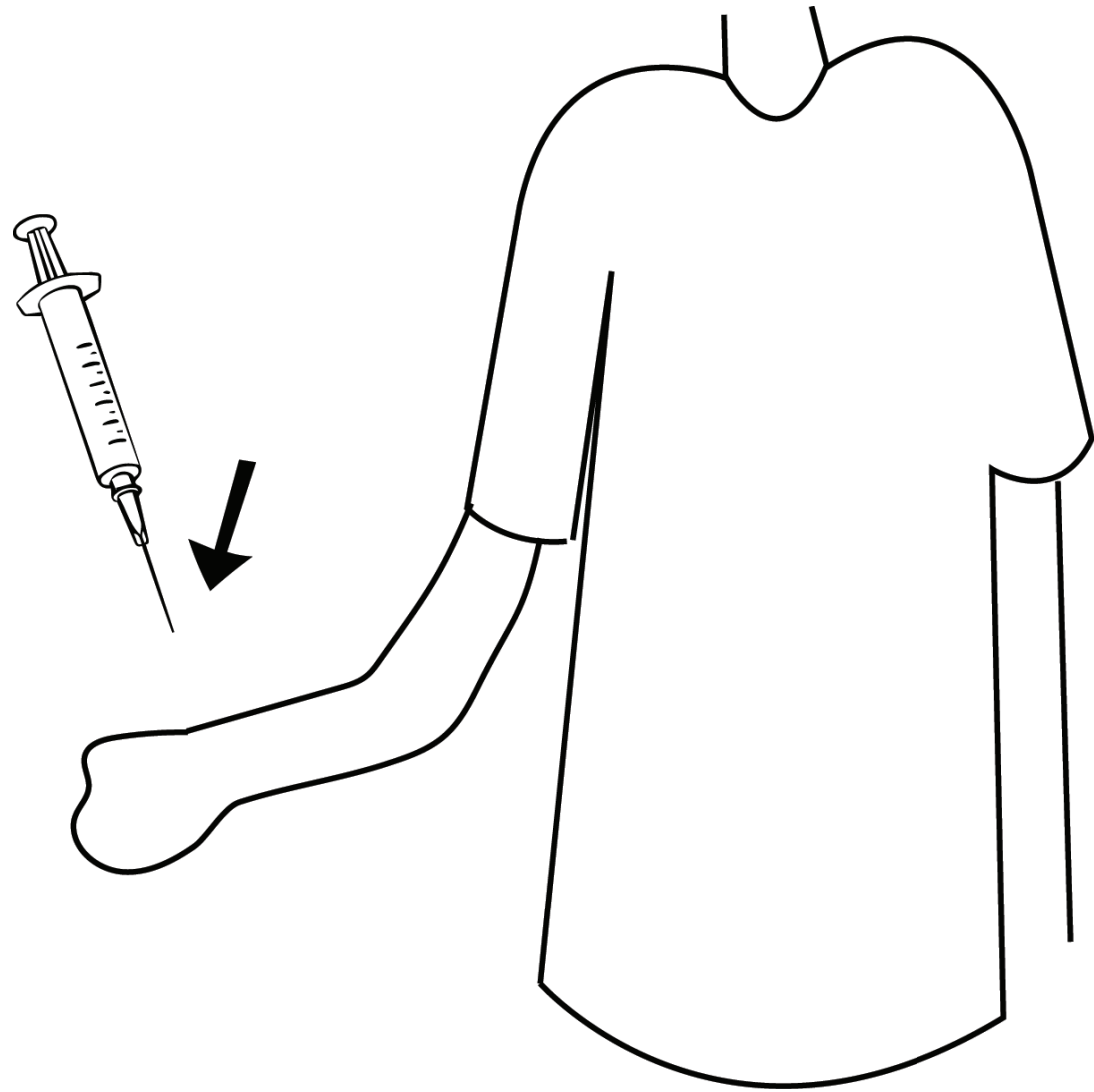

needle

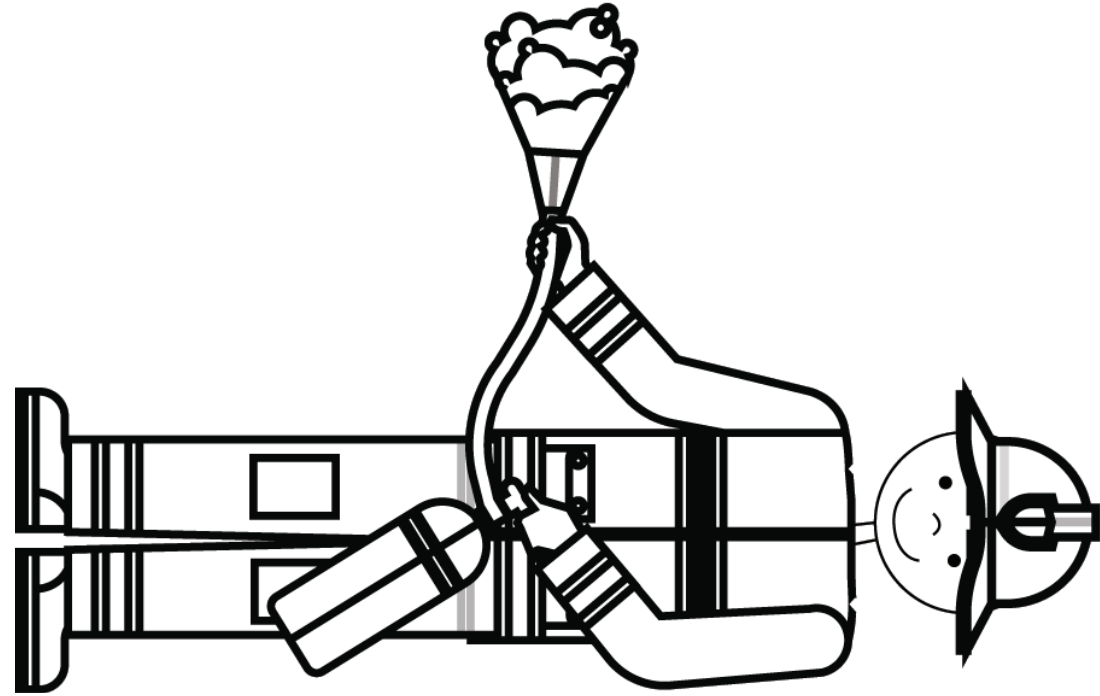
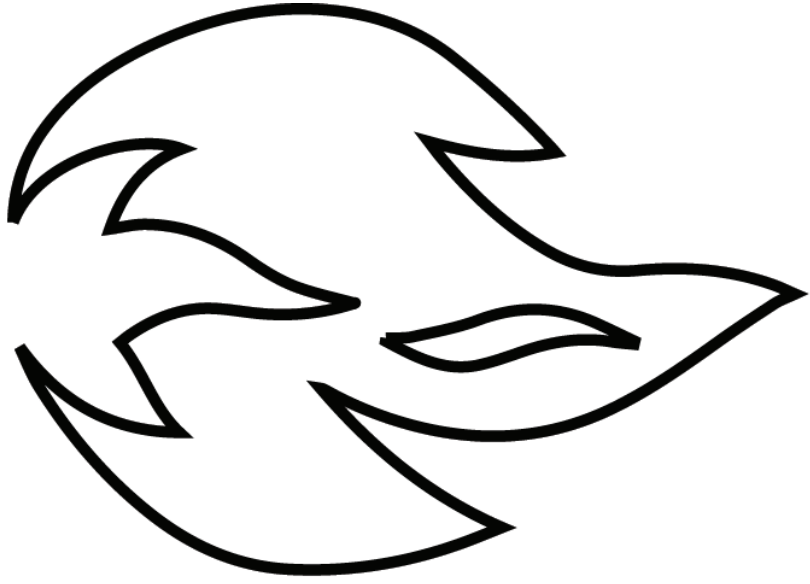

risk



dangerous

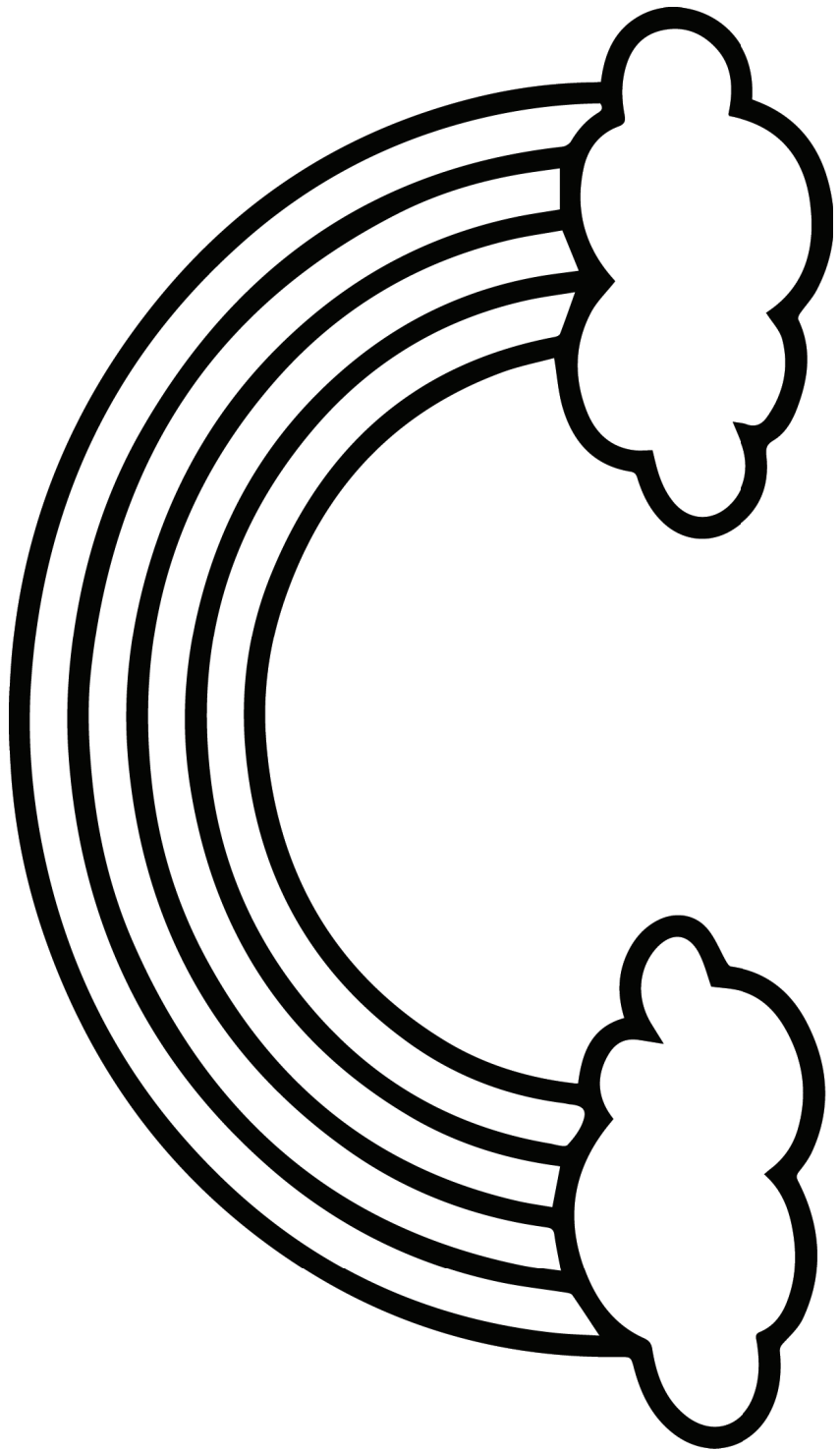

rainbow

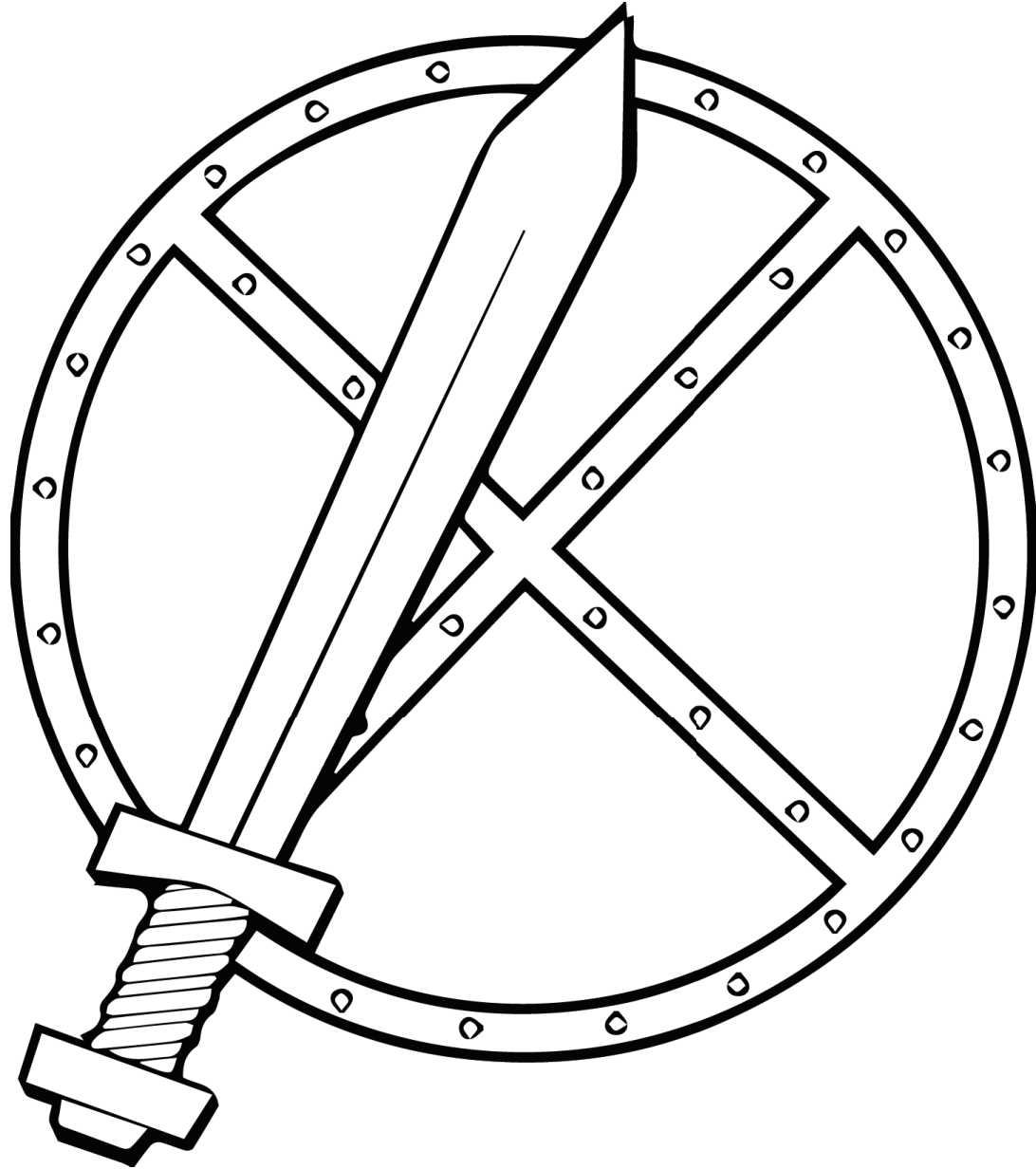

protect

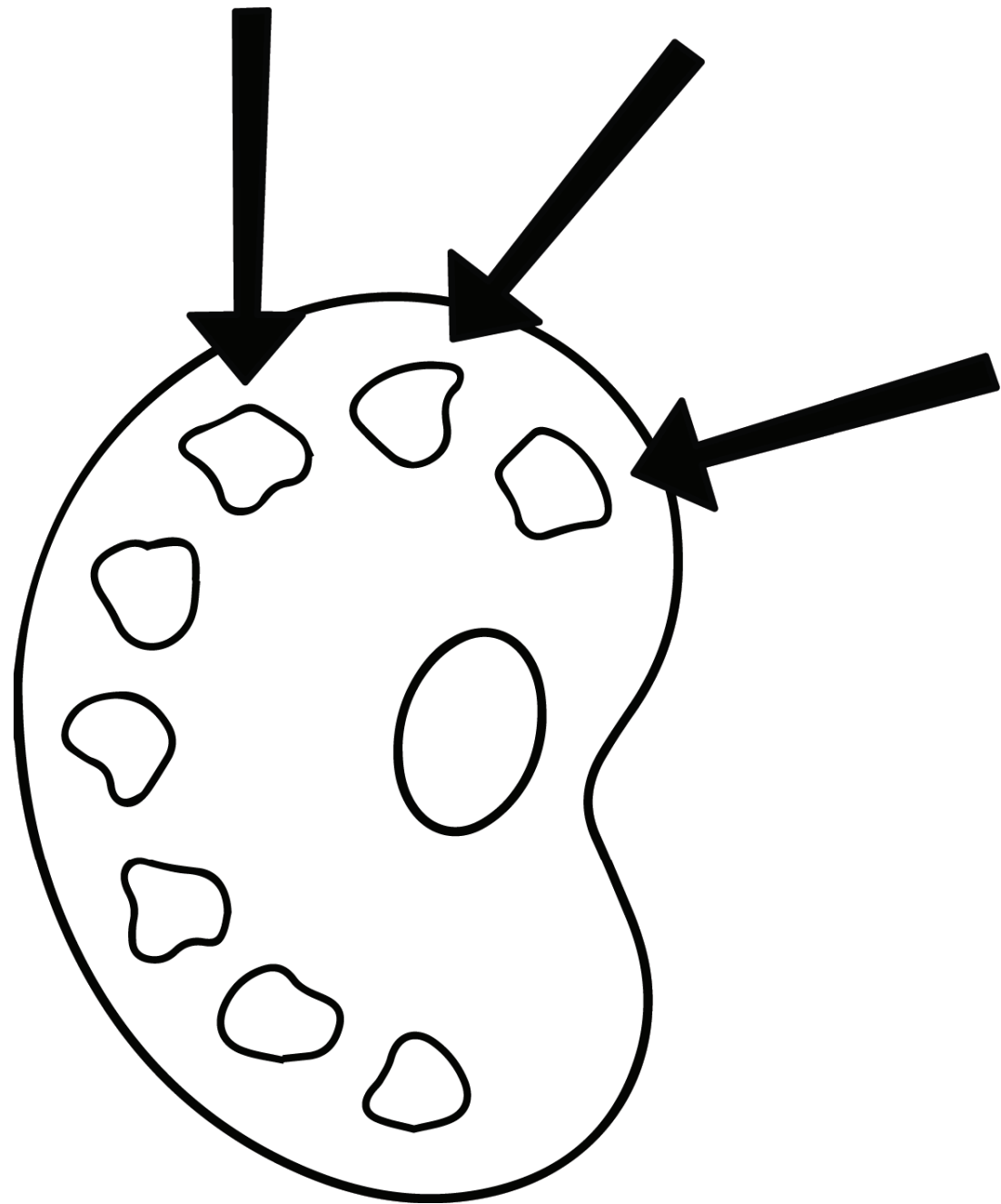

colours

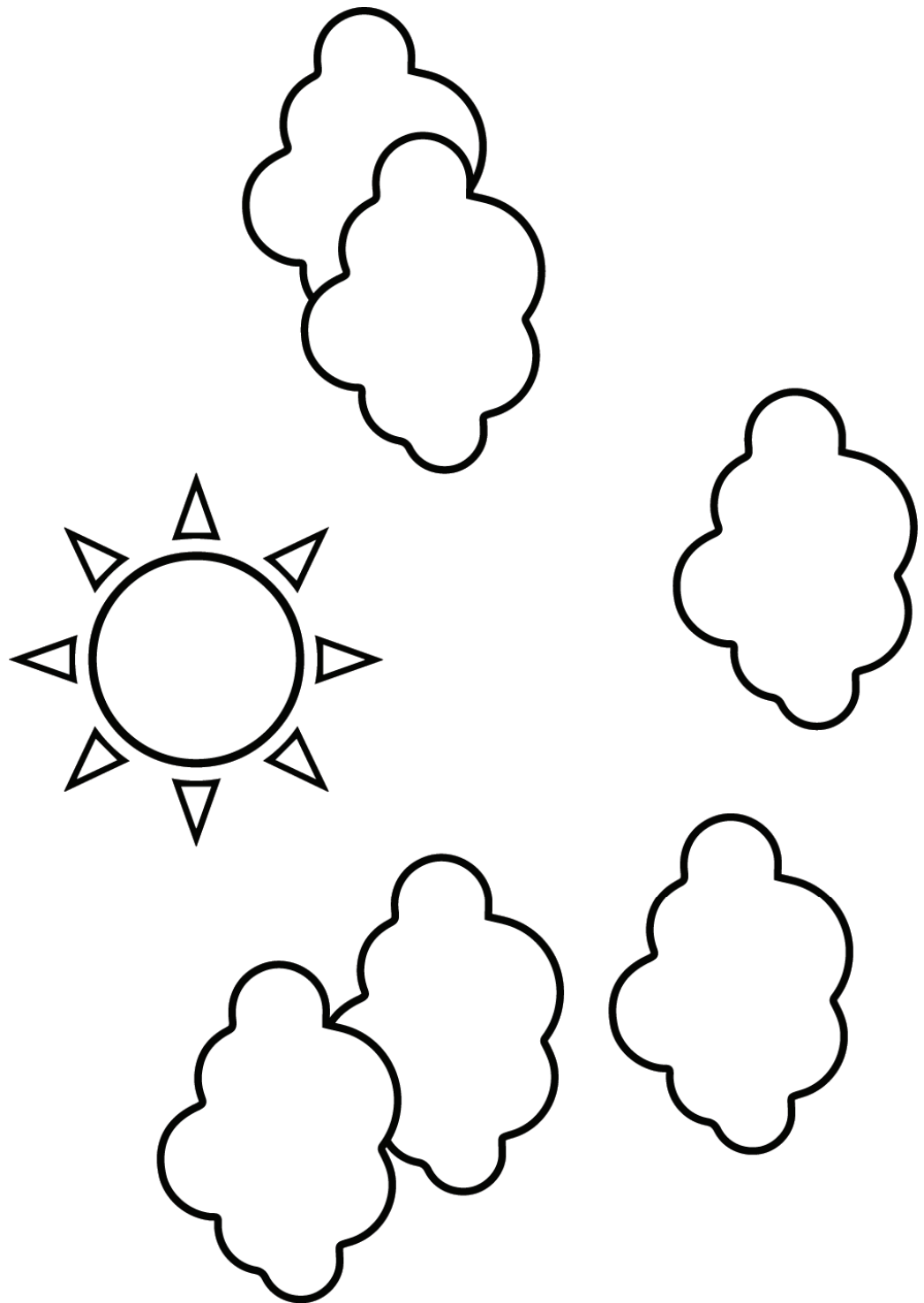

sky





rain

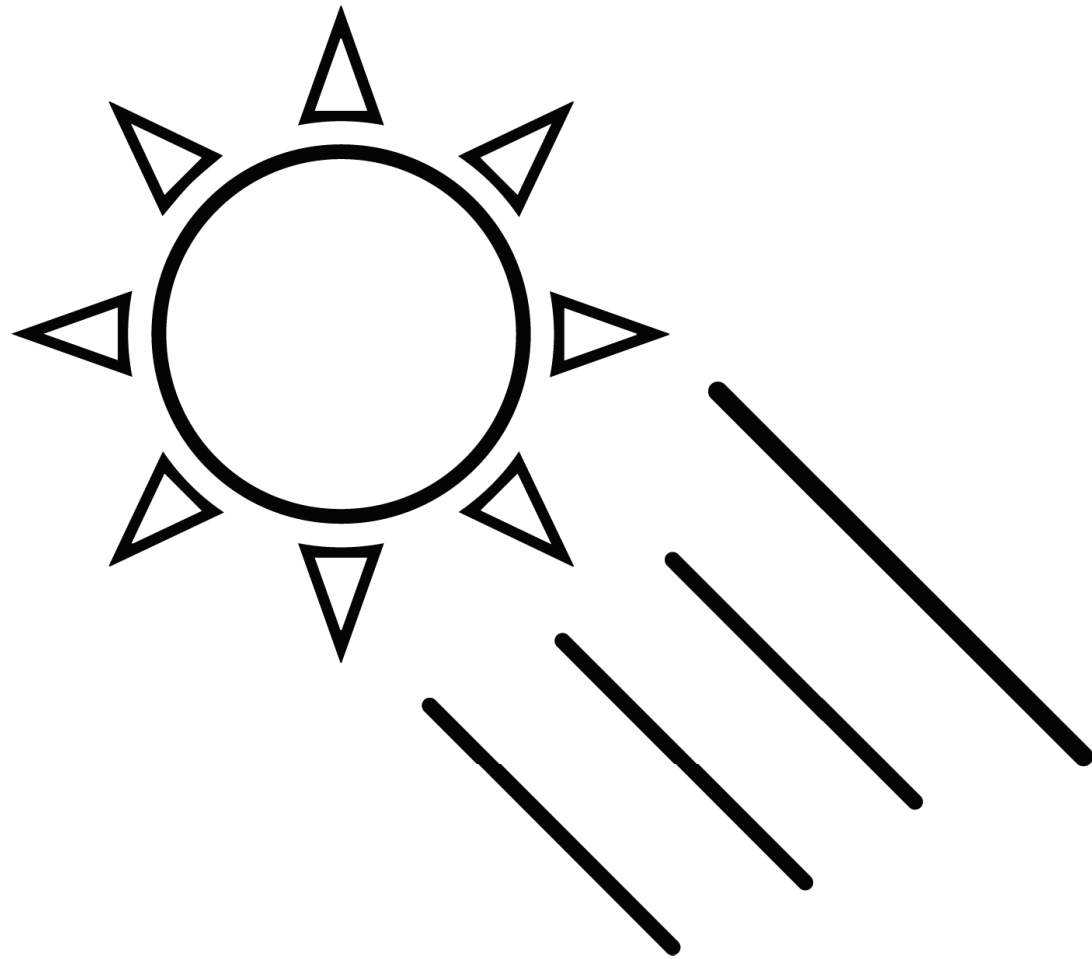

sunlight

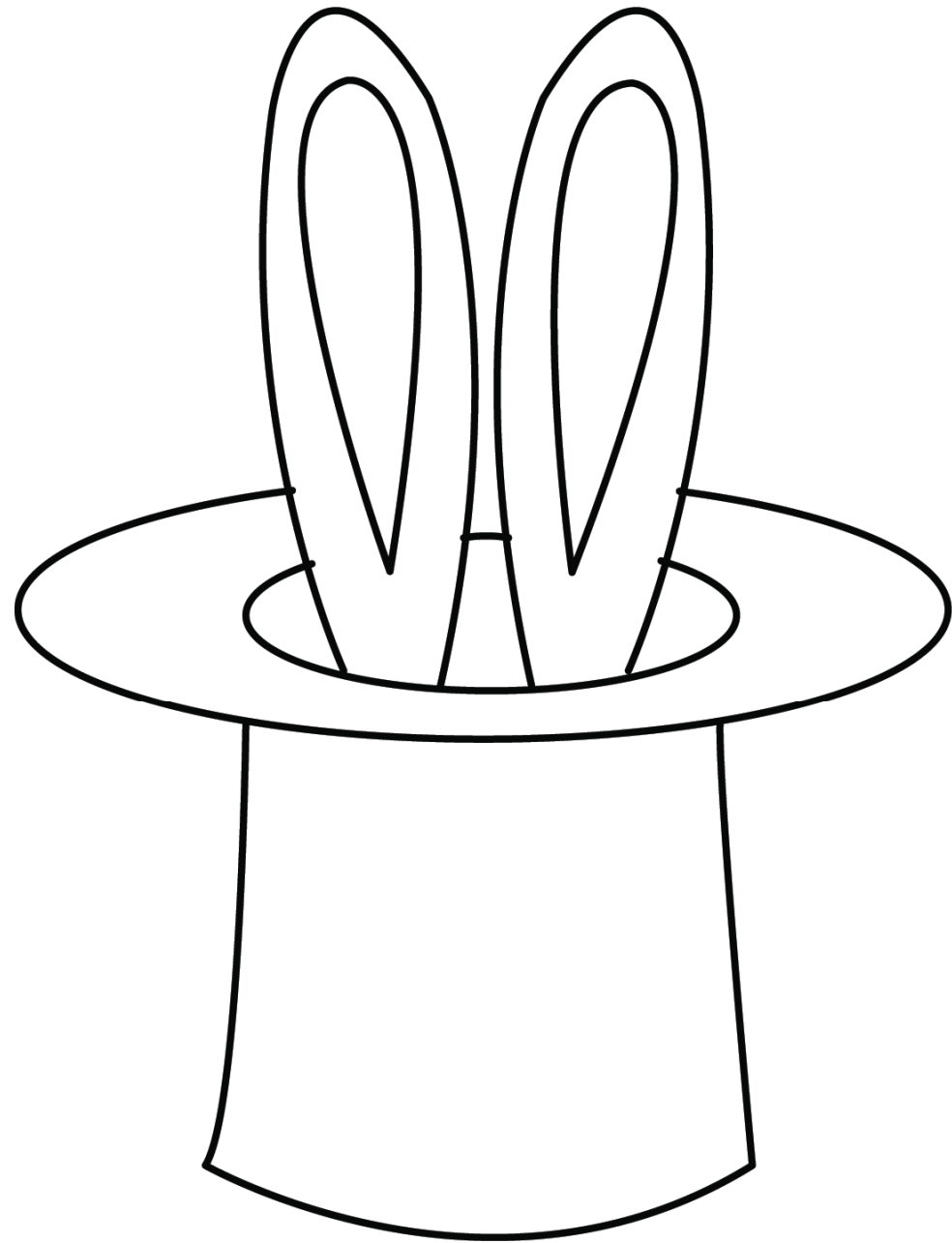

magic

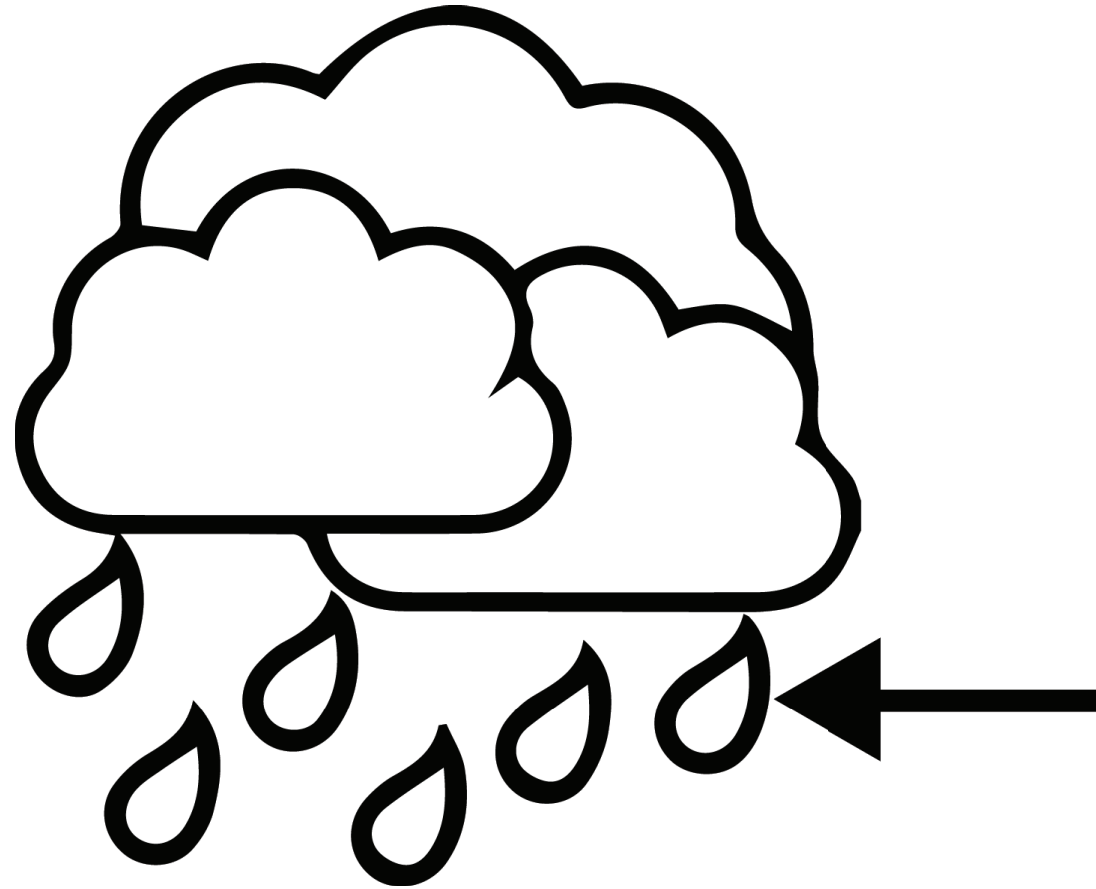

raindrop

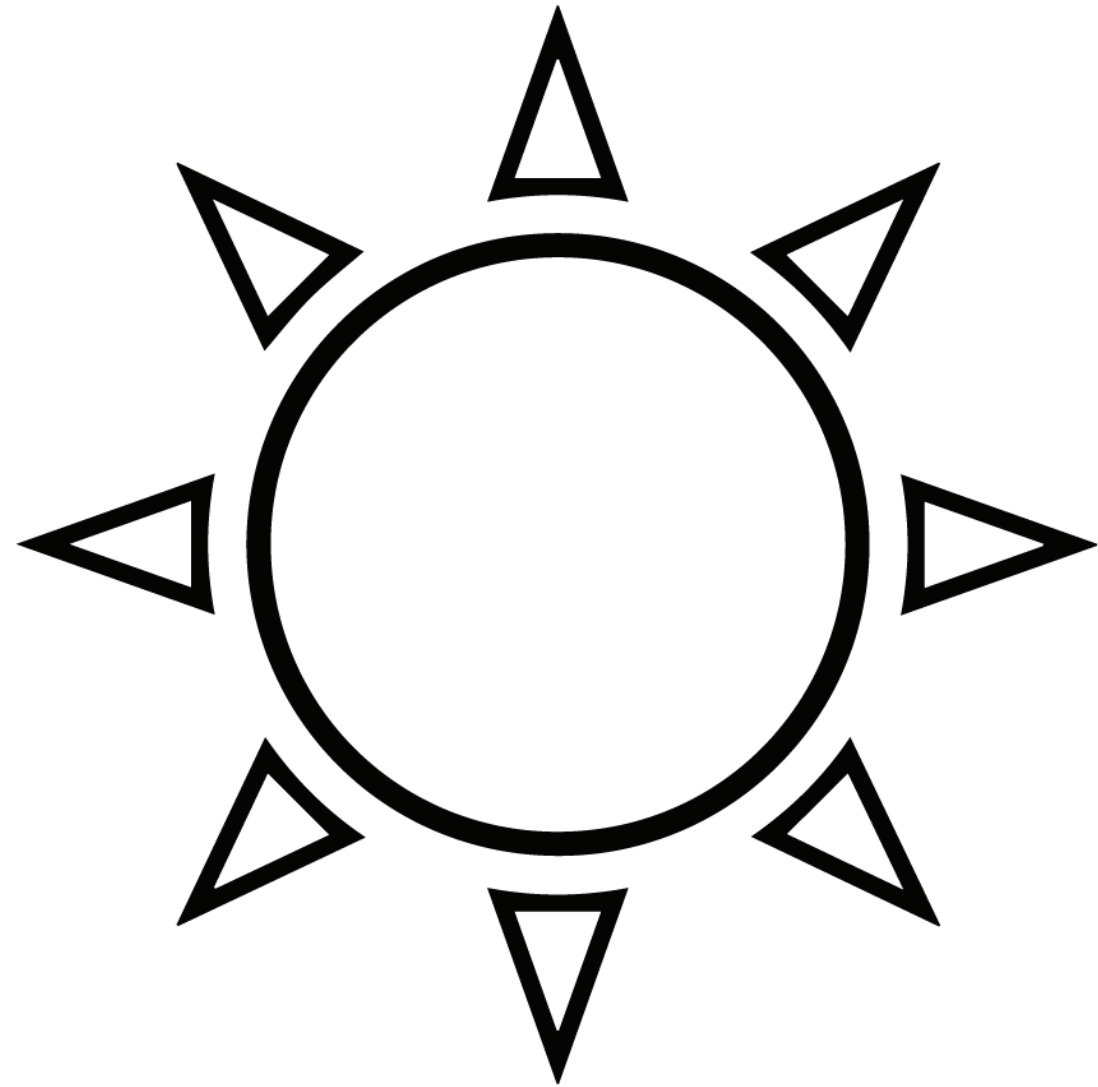

sun

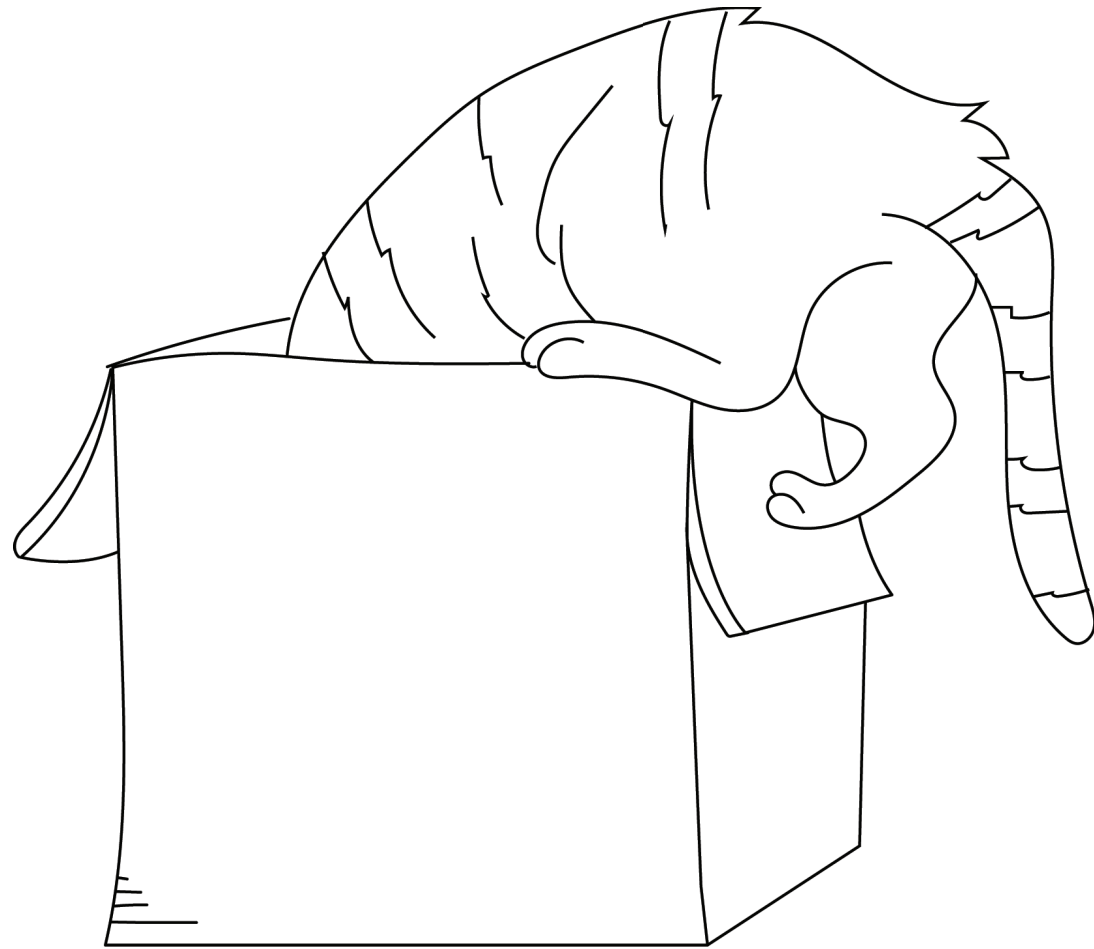

curious



storm

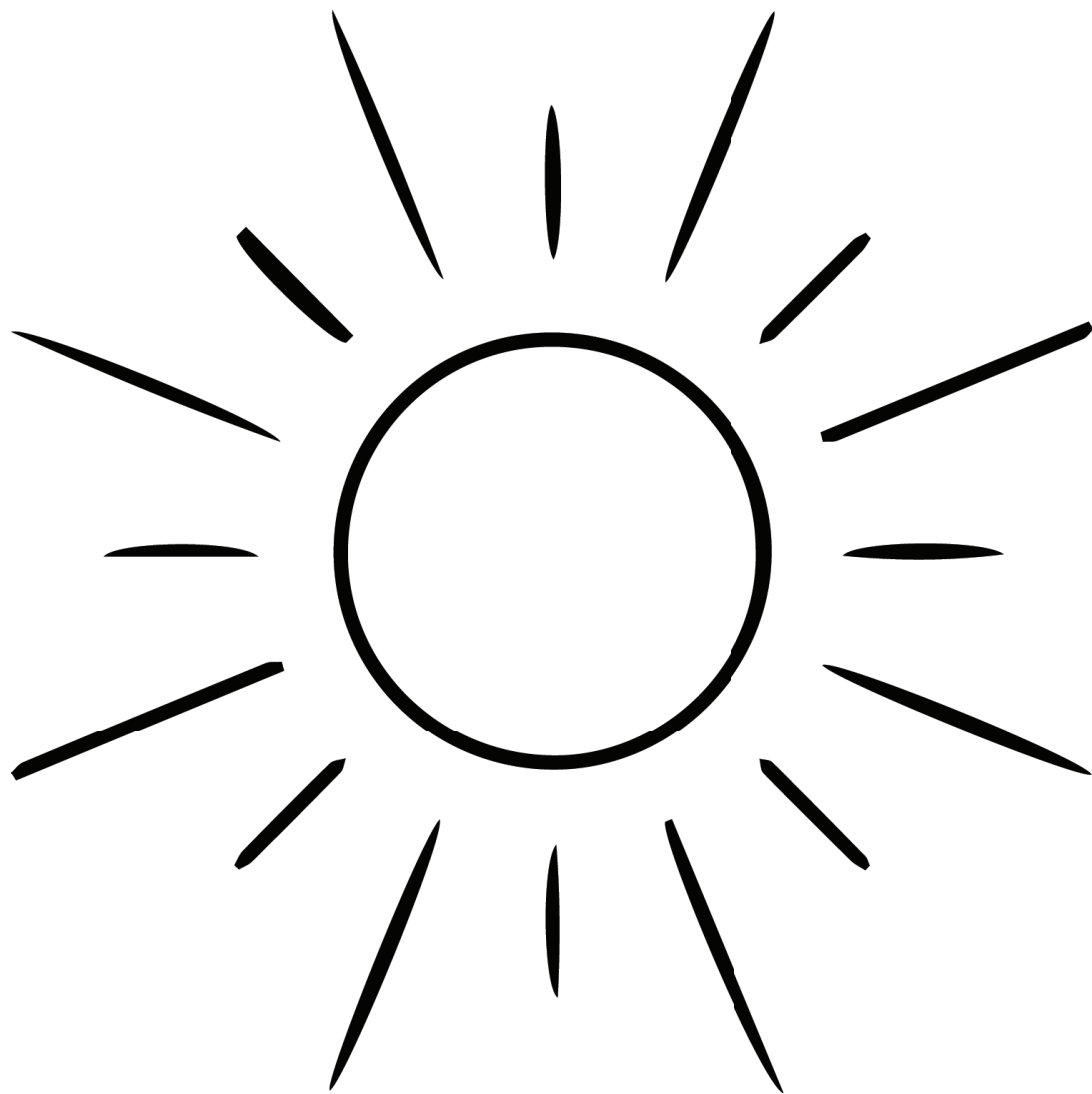

shine

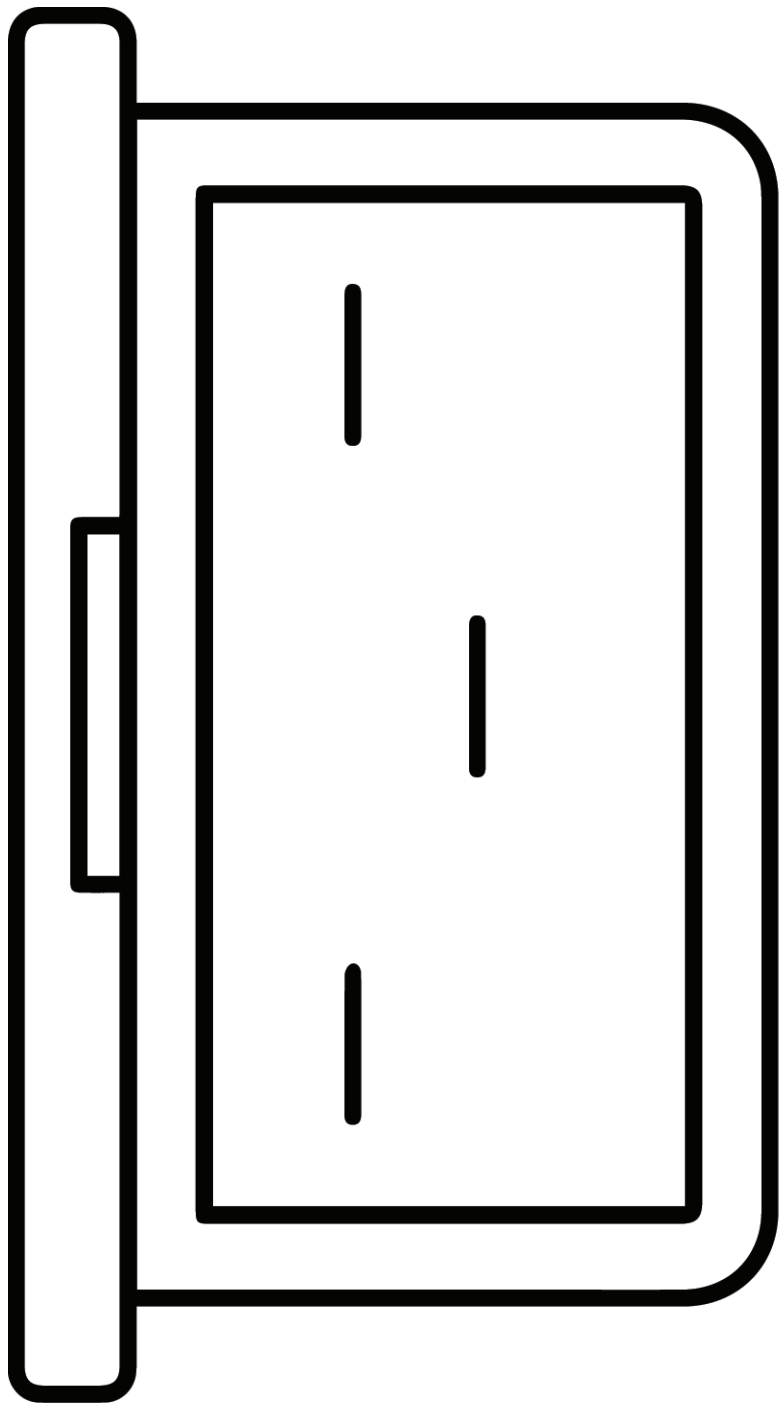

laptop

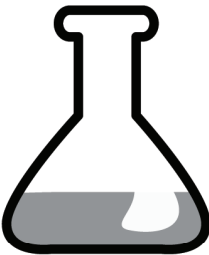
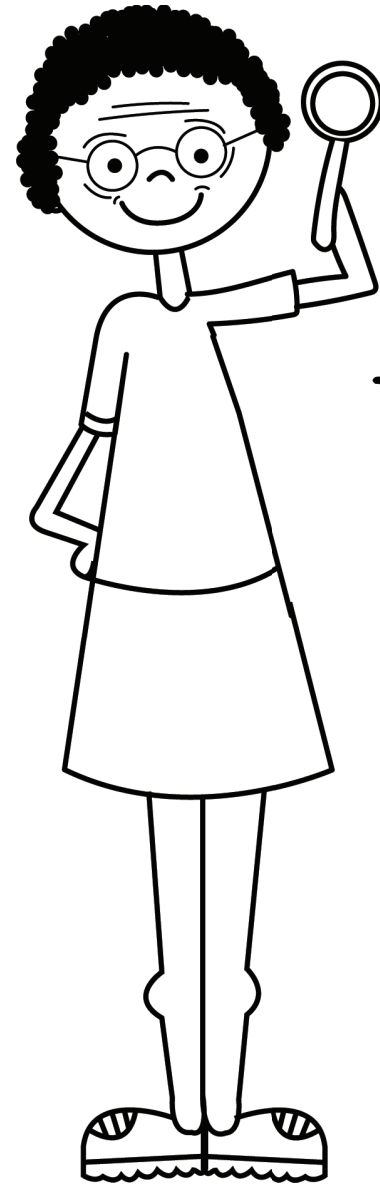
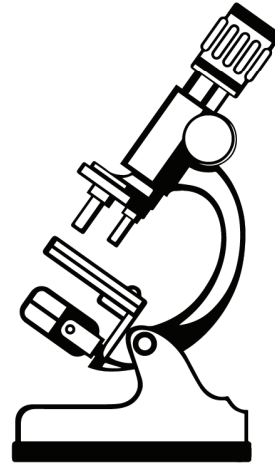
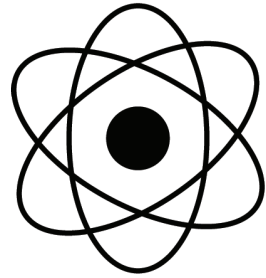

scientist

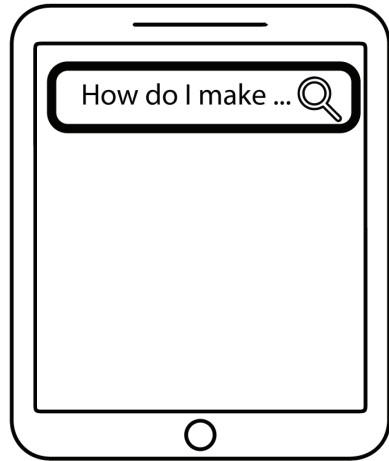
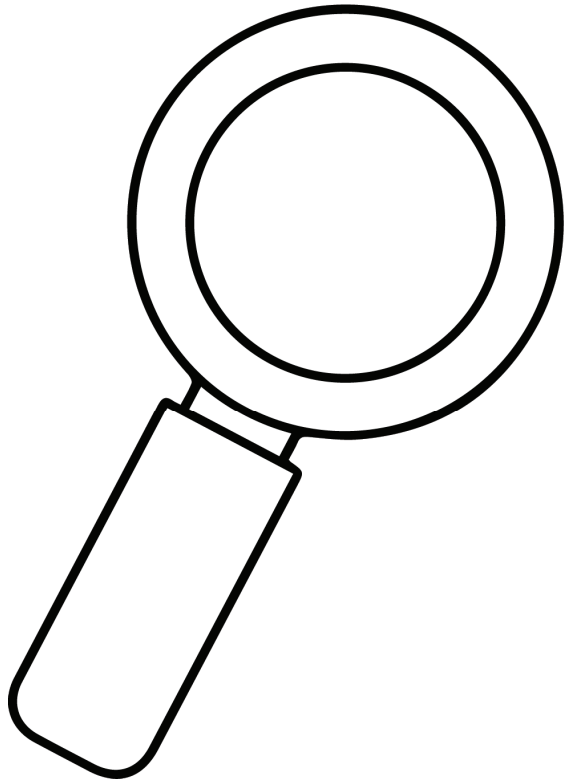
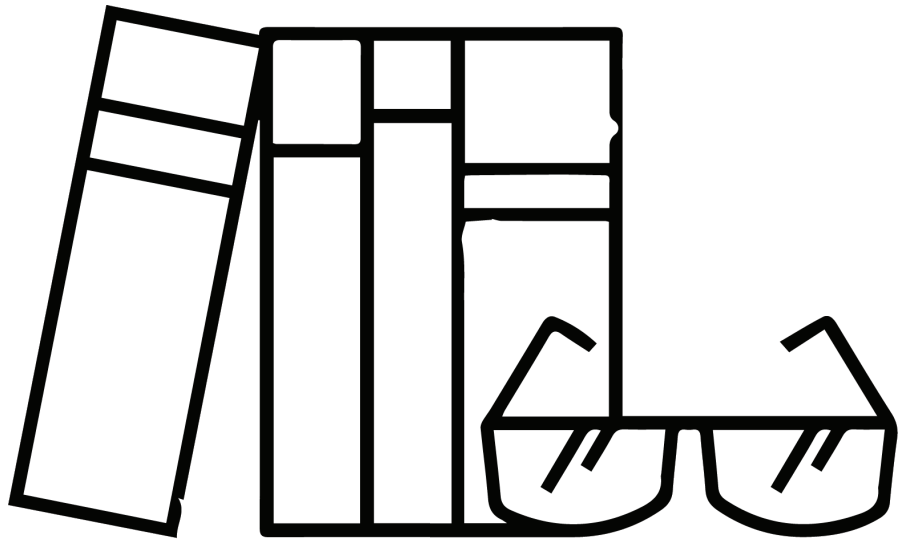

research

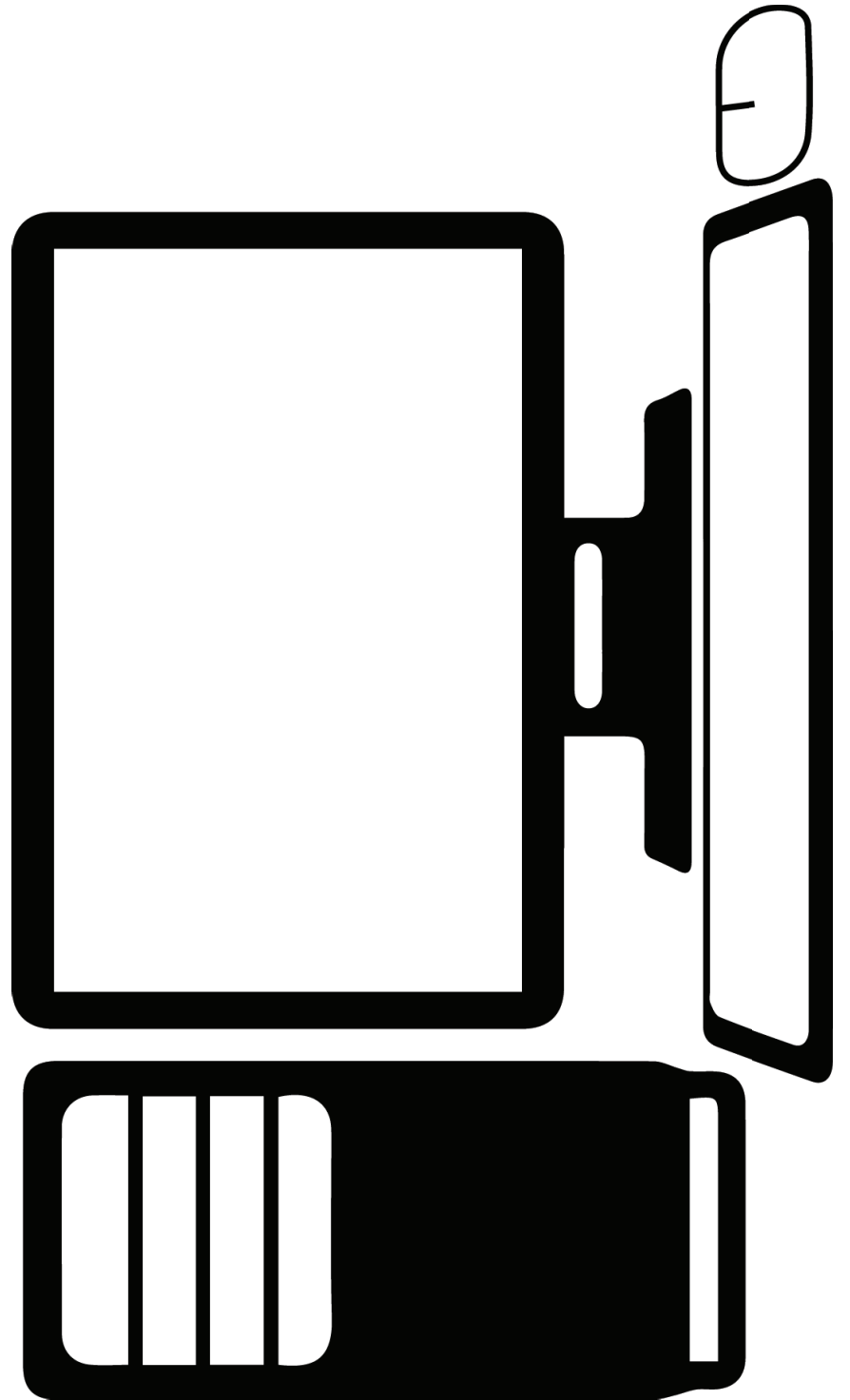

computer

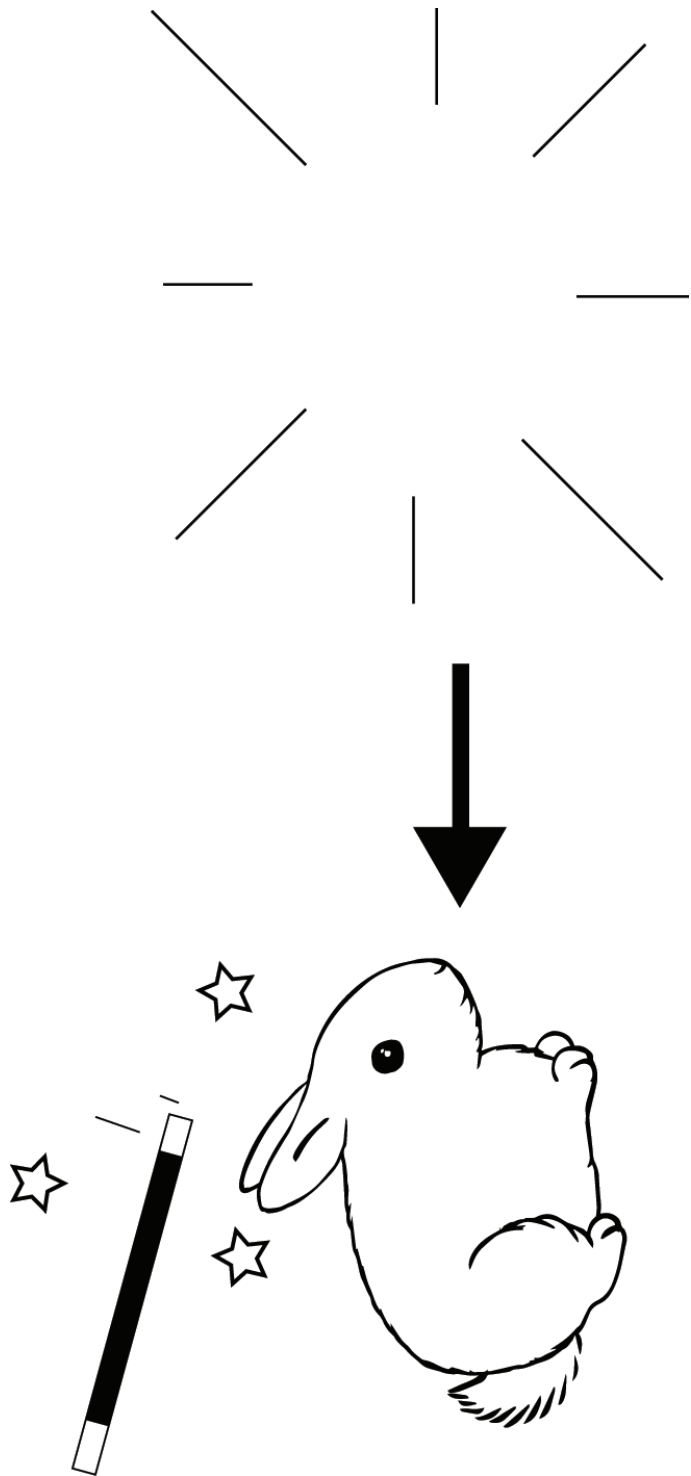

appear

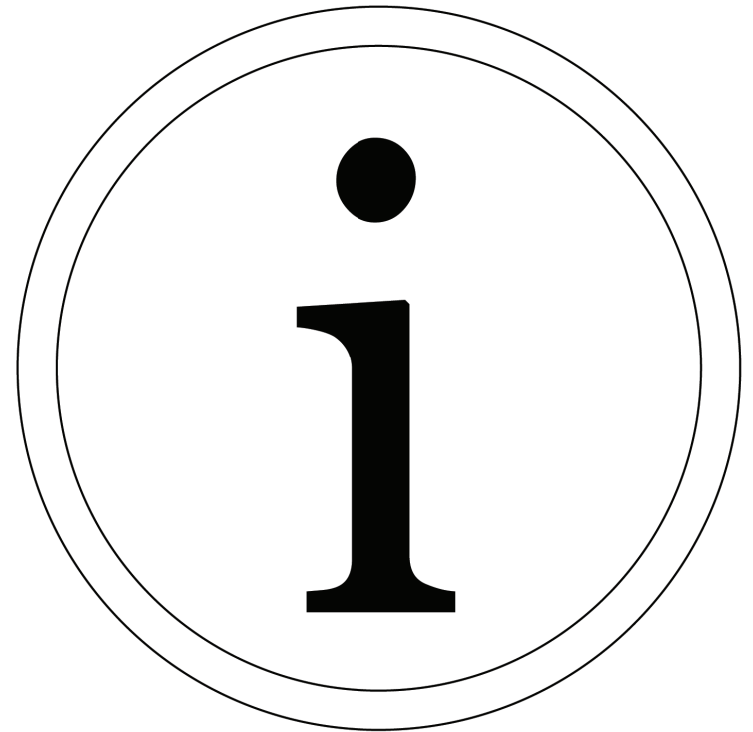
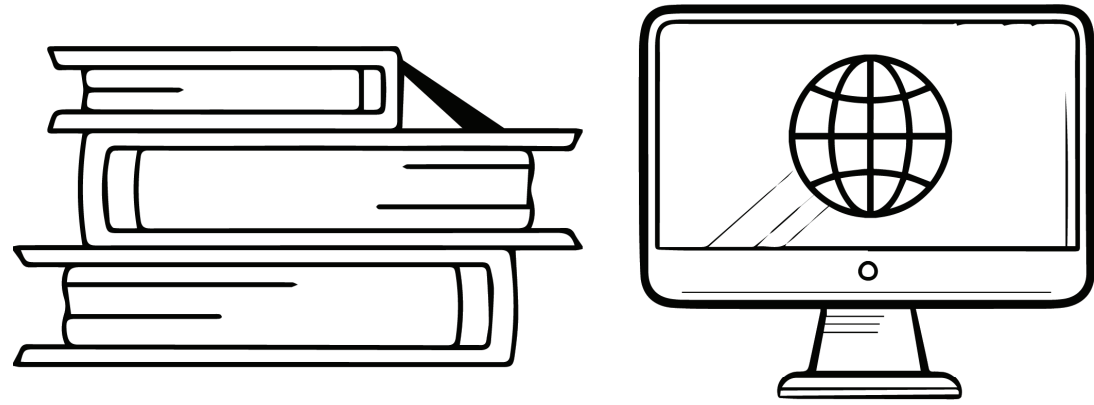

information